

Wap

CATÁLOGO DE PEÇAS PARA REPOSIÇÃO



ASPIRADOR DE PÓ ROBOT W90

FW009026

REVISÃO : 04 NOVEMBRO/2024
REFERÊNCIA - VEG02.141

O conteúdo deste documento não deve ser reproduzido ou cedido a terceiros sem a autorização prévia da Fresnomaq Indústria de Máquinas S/A



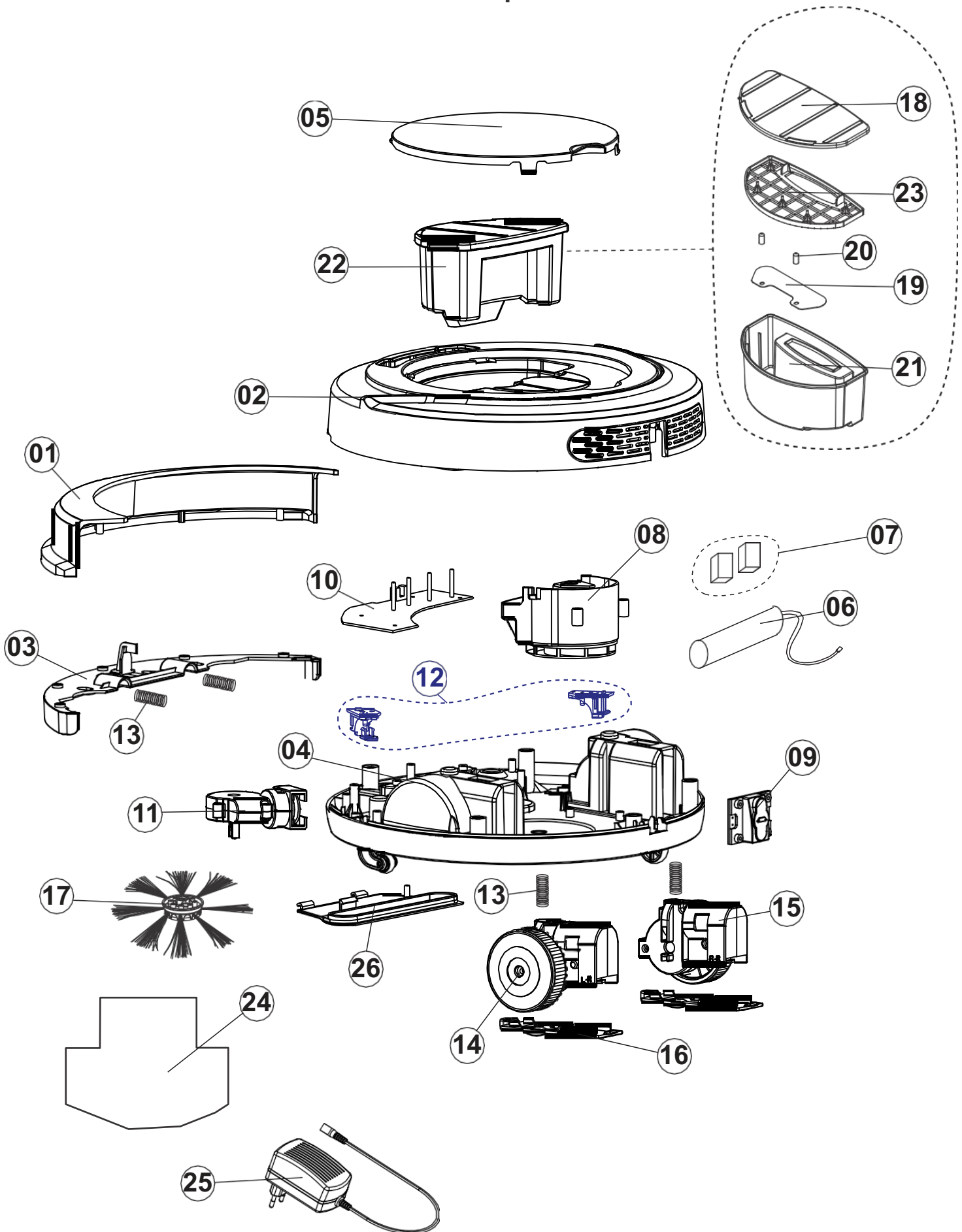





Vista Explodida

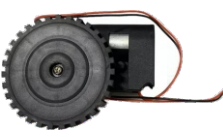
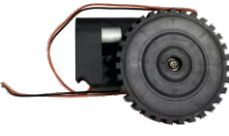

Lista de Peças

01	FW009116	PARACHOQUE FRONTAL	1	
02	FW009117	CARENAGEM SUPERIOR	1	
03	FW009118	TAMPA INFERIOR DO PARACHOQUE	1	
04	FW009119	CARENAGEM INFERIOR	1	
05	FW009120	TAMPA SUPERIOR	1	
06	FW009121	BATERIA 3.6V 2600mAh	1	
07	FW009122	KIT EVA DE SUPORTE DA BATERIA	1	
08	FW009123	KIT MOTOR SUCCÃO	1	
09	FW009124	CONECTOR DE CARGA	1	
10	FW009125	PLACA ELETRÔNICA (PCB)	1	

Lista de Peças

11	FW009126	KIT MOTOR ESCOVA FRONTAL	1	
12	FW009127	KIT SENSOR PEQUENO	1	
13	FW009128	MOLA	4	
14	FW009129	KIT MOTOR RODA ESQUERDA	1	
15	FW009130	KIT MOTOR RODA DIREITA	1	
16	FW009131	TAMPA DA RODA	2	
17	FW009132	ESCOVA FRONTAL	1	
18	FW007699	TAMPA DO FILTRO	1	
19	FW007702	TAMPA DA ENTRADA DE SUCCÃO	1	
20	FW007701	PINO DE FIXAÇÃO	2	

Lista de Peças







21	FW007703	RECIPIENTE DE PÓ	1	
22	FW008543	RECIPIENTE DE PÓ COMPLETO	1	
23	FW007700	FILTRO DE ENTRADA	1	
24	FW007845	REFIL MOP	1	
25	FW009133	CARREGADOR 5V 0.2A	1	
26	FW009436	RODO DE SUCCÃO	1	
*	FW009027	CX WAP ROBOT W90	1	-
*	FW009028	MANUAL DE INSTR WAP ROBOT W90	1	-
*	ECB00164	ETIQ C. BAR WAP ROBOT W90	1	-
*	ESL00050	ETIQ SELO RUÍDO WAP ROBOT W90	1	-

Diagrama Eléctrico



Lista de Revisões

N°	DESCRIÇÃO	DATA
00	Emissão inicial	04/08/2022
01	Ajuste no item FW009122	17/01/2023
02	Inclusão do item FW009436	31/03/2023
03	Alteração do nome do kit sensor (FW009127)	16/07/2024
04	Atualização na vista explodida	16/07/2024

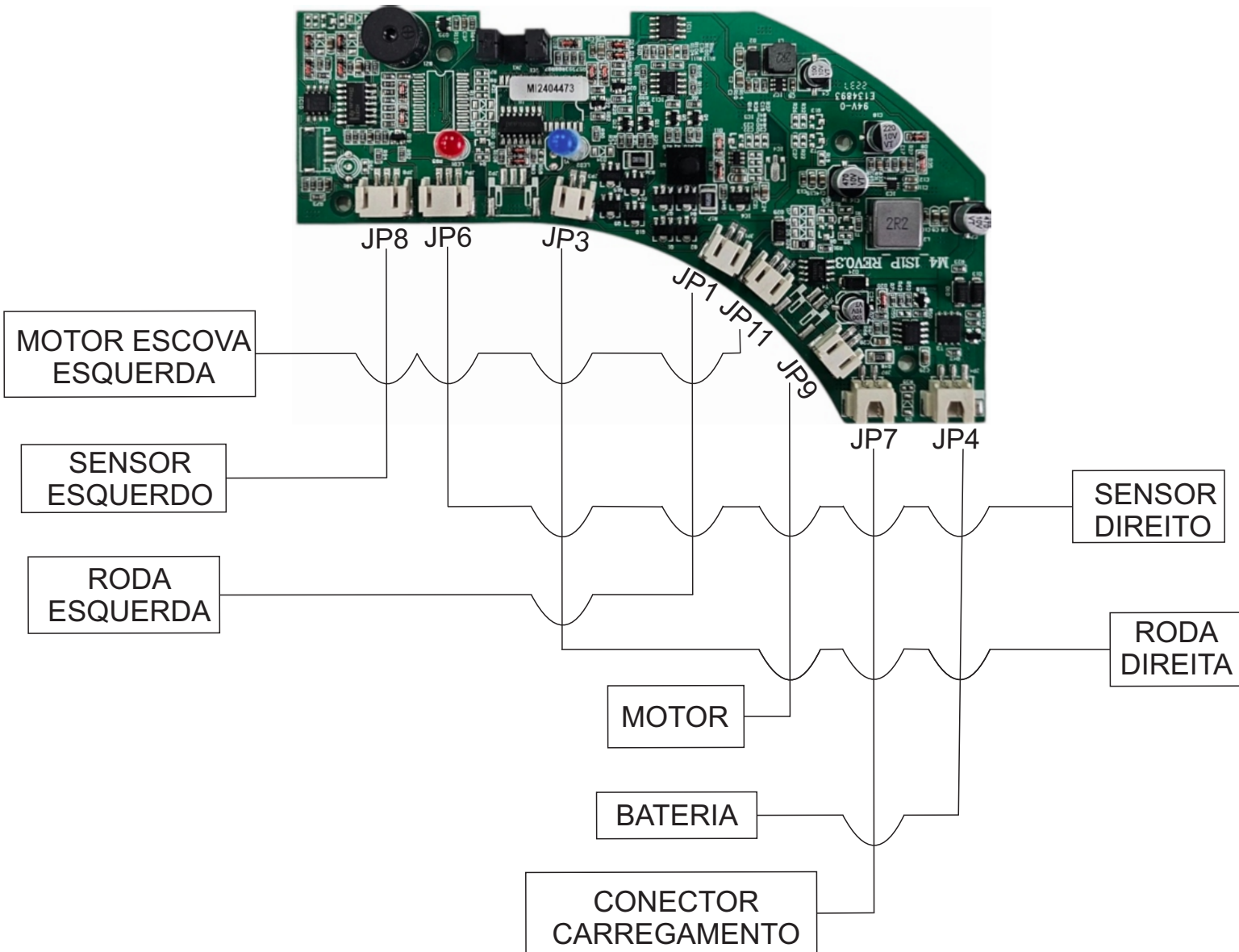

Fresnomaq Indústria de Máquinas S/A
Tel.: (41) 3513-9600 - Fax: (41) 3513-9630
Rua Antônio Singer, 200 - São José dos Pinhais, PR, Brasil
www.wap.ind.br - wap@wap.ind.br