

# Wap

## CATÁLOGO DE PEÇAS PARA REPOSIÇÃO



## WL 1820 / WL 1820 ULTRA

FW009451 - 127V  
FW009452 - 220V  
FW009453 - 127V  
FW009454 - 220V

REVISÃO:01- OUTUBRO/2024  
REFERÊNCIA: VEG02.172

O conteúdo deste documento não deve ser reproduzido ou cedido a terceiros sem a autorização prévia da Fresnomaq Indústria de Máquinas S/A

# Vista Explodida

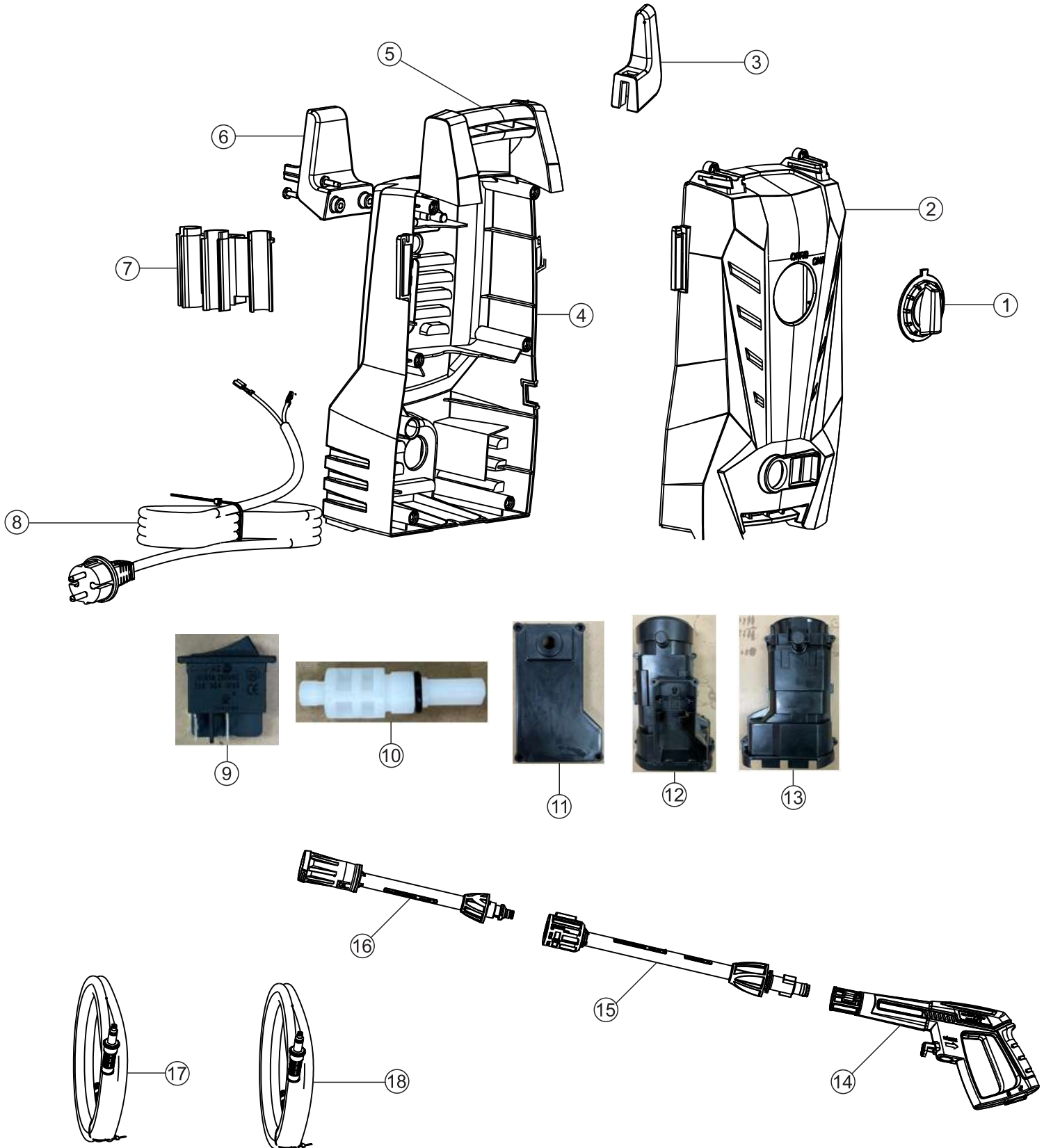

# Vista Explodida

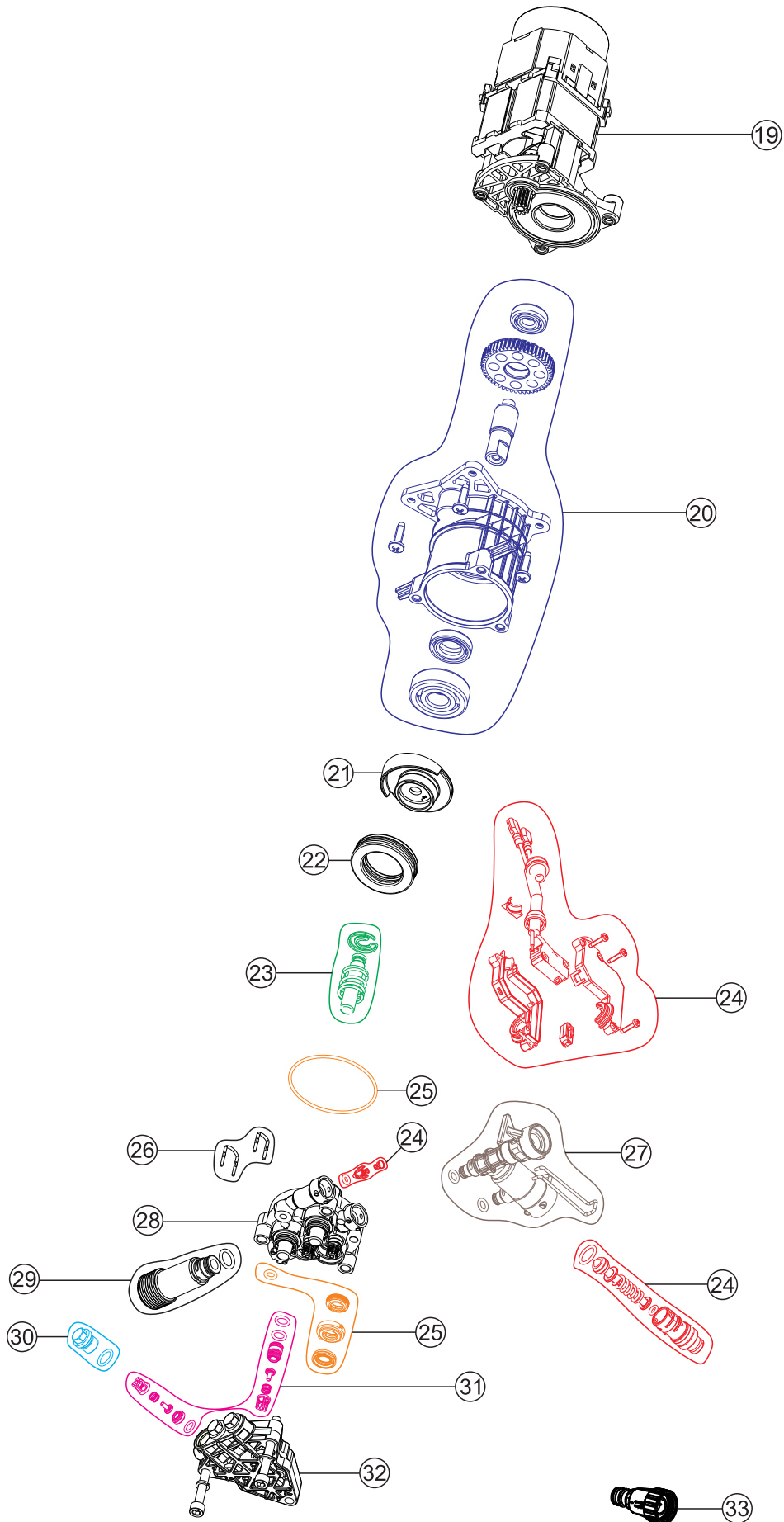









# Lista de Peças

POS	CÓDIGO	DESCRIÇÃO	QUANT.	FOTO
1	FW009685	BOTÃO DO INTERRUPTOR	1	
2	<b>FW009679</b>	CARENAGEM FRONTAL	1	
3	FW009676	SUPORE P/ CABO ELÉTRICO	1	
4	FW009678	CARENAGEM TRASEIRA	1	
5	FW009677	ALÇA	1	
6	FW009675	SUPORE DA MANGUEIRA	1	
7	FW009680	PORTA ACESSÓRIOS	1	
8	FW009667	CABO ELÉTRICO 2x1 mm <sup>2</sup> 2 PINO 4mm	1	
	FW009668	CABO ELÉTRICO 2x0,75 mm <sup>2</sup> 2 PINO 4mm	1	

# Lista de Peças

POS	CÓDIGO	DESCRIÇÃO	QUANT.	FOTO
9	FW009641	INTERRUPTOR ELÉTRICO	1	
10	FW009642	ACIONADOR DO INTERRUPTOR	1	
11	FW009643	TAMPA DA CAIXA ELÉTRICA	1	
12	FW009645	TAMPA PROTETOR DO MOTOR	1	
13	FW009644	TAMPA INFERIOR DO MOTOR	1	
14	FW009674	PISTOLA DE ALTA PRESSÃO	1	
15	FW009671	BAIONETA	1	
16	FW009670	LANÇA C/ BICO REGULÁVEL	1	
17	FW009672	MANGUEIRA DE ALTA PRESSÃO	1	
18	FW006951	MANGUEIRA DESENTUPIDORA	1	

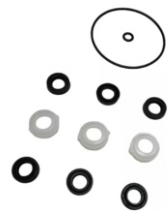
# Lista de Peças

POS	CÓDIGO	DESCRIÇÃO	QUANT.	FOTO
19	FW009664	MOTOR 127V 50/60 HZ	1	
	FW009665	MOTOR 220V 50/ 60 HZ	1	
20	FW009666	KIT CARTER ENGRENAGEM	1	
21	FW009661	CAME 9,3°	1	
22	FW009650	ROLAMENTO AXIAL	1	
23	FW009649	KIT PISTÃO (C/ 3 UNIDADES)	1	
24	FW009646	KIT MICROSWITCH	1	
25	FW009663	KIT VEDAÇÃO (C/ 3 UNID.)	1	
26	FW009651	KIT PINO TRAVA (C/ 4 UNIDADES)	1	

# Lista de Peças

POS	CÓDIGO	DESCRIÇÃO	QUANT.	FOTO
27	FW009647	CONEXÃO SAÍDA DE ÁGUA	1	
28	FW009660	GUIA PISTÃO	1	
29	FW011231	KIT CONEXÃO ENTRADA DE ÁGUA 48mm	1	
30	FW009652	KIT TAMPÃO (C/ 3 UNIDADES)	1	
31	FW009662	KIT VÁLVULA SUÇÃO/ PRESSÃO (C/ 6 UNIDADES)	1	
32	FW009659	CABEÇOTE DE ALUMÍNIO	1	
33	FW006859	ESPIGÃO ENGATE RÁPIDO CPL	1	
*	FW009491	MANUAL DE INSTR WAP WL 1820	1	-
*	FW009492	CX WAP WL 1820	1	-
*	ECB00217	ETIQ C. BAR WAP WL 1820 127V	1	-
*	ECB00218	ETIQ C. BAR WAP WL 1820 220V	1	-
*	ECB00219	ETIQ C. BAR WAP WL 1820 ULTRA 127V	1	-
*	ECB00220	ETIQ C. BAR WAP WL 1820 ULTRA 220V	1	-

# Lista de Revisões

N°	DESCRIÇÃO	DATA
0	EMISSÃO INICIAL	13/11/2023
01	substituição do item FW009648 para FW011231	17/10/2024





Fresnomaq Indústria de Máquinas S/A  
Tel.: (41) 3513 9600 - Fax: 3513 9630  
Rua Antônio Singer, 200, São José dos Pinhais, PR - Brasil  
[www.wap.ind.br](http://www.wap.ind.br) - [wap@wap.ind.br](mailto:wap@wap.ind.br)