

Wap

CATÁLOGO DE PEÇAS PARA REPOSIÇÃO



LAVADORA DE ALTA PRESSÃO WL 2660 TURBO / WL 2660 TURBO ULTRA

FW009595 (127V)
FW009596 (220V)

ULTRA - FW009459 (127V)
ULTRA - FW009460 (220V)

REVISÃO : 03 - JANEIRO/2025
REFERÊNCIA - VEG02.176

O conteúdo deste documento não deve ser reproduzido ou cedido a terceiros sem a autorização prévia da Fresnomaq Indústria de Máquinas S/A

Vista Explodida Carenagem

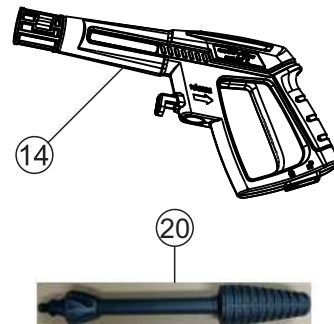
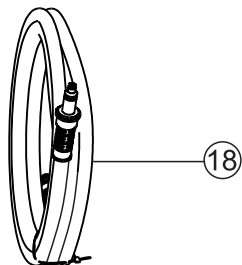
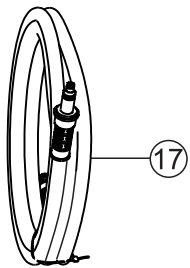
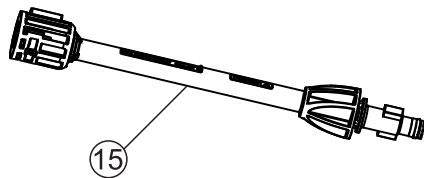
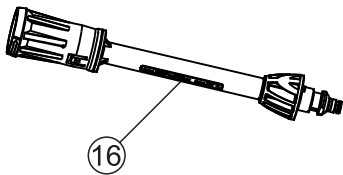
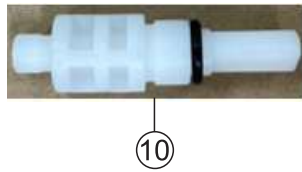
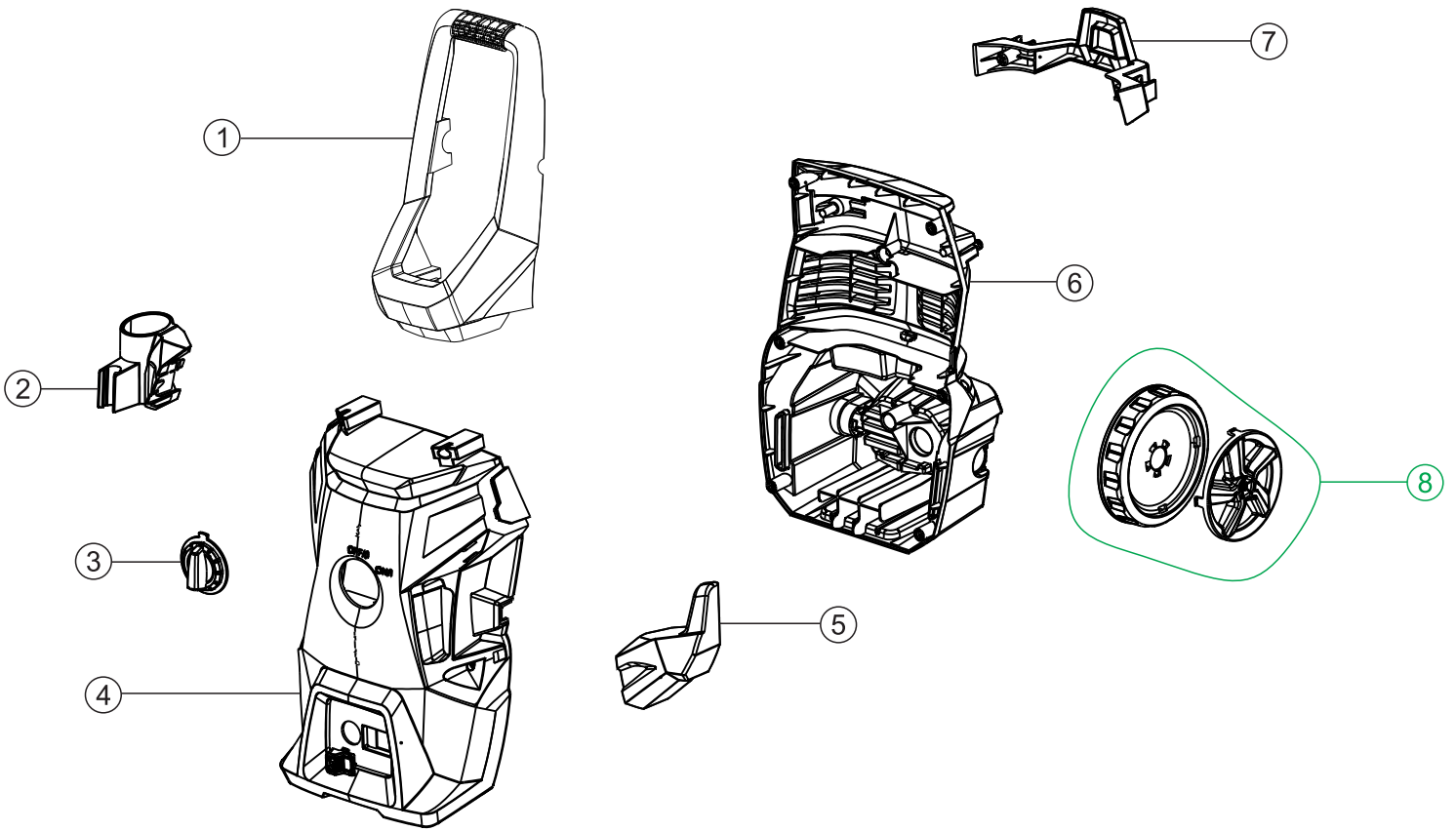

Lista de Peças

01	FW009683	ALÇA LONGA	1	
02	FW009653	SUPORE DA PISTOLA	1	
03	FW009685	BOTÃO DO INTERRUPTOR	1	
04	FW009686	CARENAGEM FRONTAL	1	
05	FW009654	SUPORE P/ CABO ELÉTRICO	1	
06	FW009684	CARENAGEM TRASEIRA	1	
07	FW009673	PORTA ACESSÓRIOS	1	
08	FW009690	KIT RODA E CALOTA	2	
09	FW009641	INTERRUPTOR ELÉTRICO	1	
10	FW009642	ACIONADOR DO INTERRUPTOR	1	







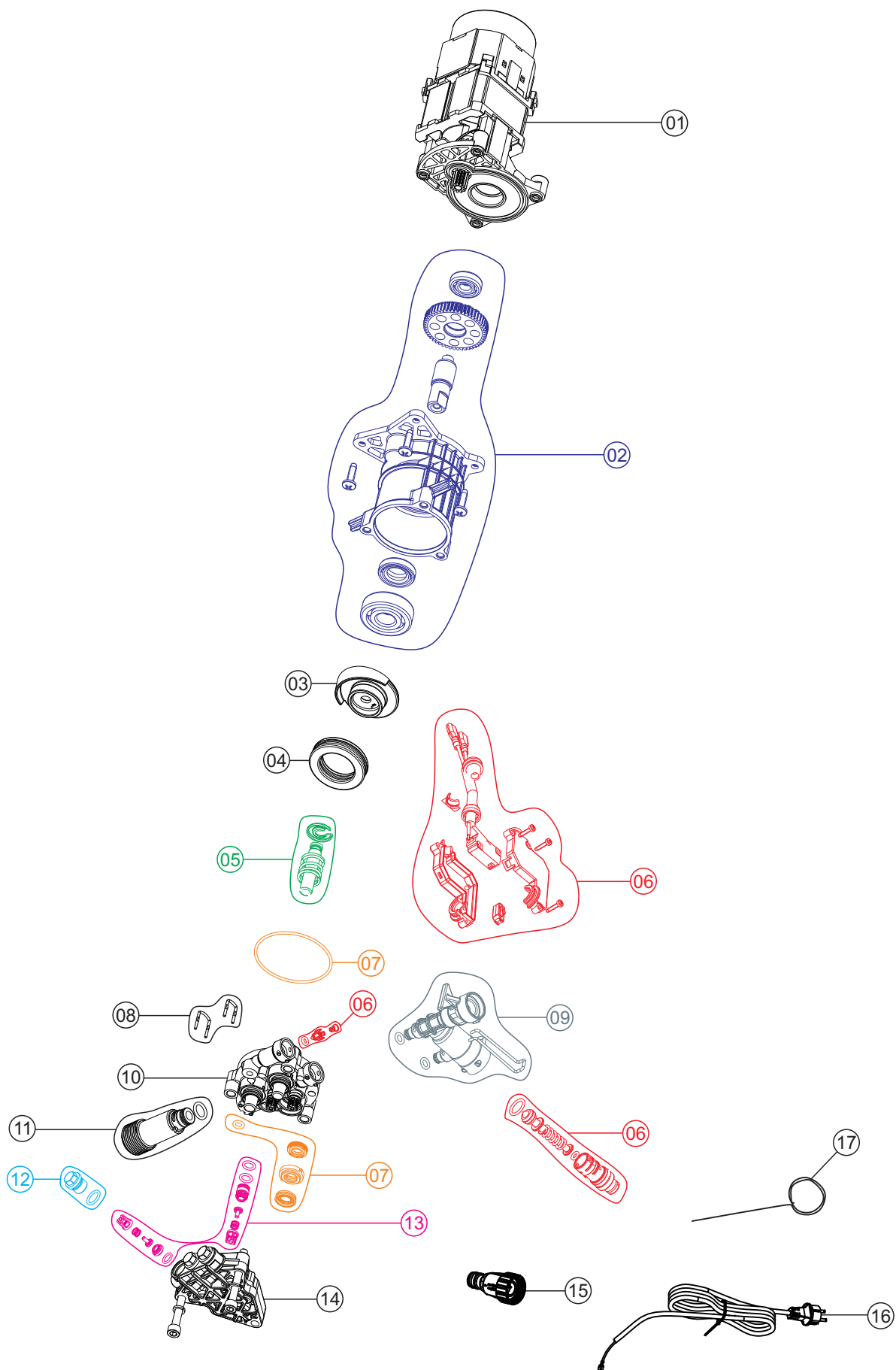



Lista de Peças

11	FW009695	TAMPA DA CAIXA ELÉTRICA	1	
12	FW009697	TAMPA SUPERIOR DO MOTOR	1	
13	FW009696	TAMPA INFERIOR DO MOTOR	1	
14	FW009674	PISTOLA DE ALTA PRESSÃO	1	
15	FW009692	BAIONETA	1	
16	FW009691	LANÇA C/ BICO REGULÁVEL	1	
17	FW009672	MANGUEIRA DE ALTA PRESSÃO NYLON 5 METROS	1	
18	FW006951	MANGUEIRA DESENTUPIDORA	1	
19	FW009693	APLICADOR DE DETERGENTE	1	
20	FW009694	BICO TURBO	1	



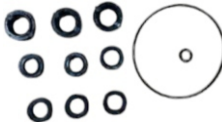



Vista Explodida Conj. Motorbomba



Lista de Peças

01	FW009688	MOTOR ELÉTRICO UNIVERSAL 127V 50/60 HZ	1	
	FW009689	MOTOR ELÉTRICO UNIVERSAL 220V 50/60 HZ		
02	FW009666	KIT CARTER ENGRENAGEM	1	
03	FW009687	CAME	1	
04	FW009650	ROLAMENTO AXIAL	1	
05	FW009649	KIT PISTÃO (C/ 3 UNIDADES)	1	
06	FW009681	KIT MICROSWITCH	1	
07	FW009663	KIT VEDAÇÃO (C/ 3 UNIDADES)	1	
08	FW009651	KIT PINO TRAVA (C/ 4 UNIDADES)	1	
09	FW009682	KIT CONEXÃO SAÍDA DE ÁGUA	1	
10	FW009660	GUIA PISTÃO	1	

Lista de Peças

11	FW009648	KIT CONEXÃO ENTRADA DE ÁGUA 80mm	1	
12	FW009652	KIT TAMPÃO (C/ 3 UNIDADES)	1	
13	FW009662	KIT VÁLVULA SUÇÇÃO/ PRESSÃO (C/ 6 UNIDADES)	1	
14	FW009659	CABEÇOTE DE ALUMÍNIO	1	
15	FW006859	ESPIGÃO ENGATE RÁPIDO CPL	1	
16	FW009667	CABO ELÉTRICO 2X1 mm ² 2 PINO 4mm	1	
	FW009668	CABO ELÉTRICO 2X0,75 mm ² 2 PINO 4mm		
17	FW006893	AGULHA LIMPA BICO	1	
*	FW009635	MANUAL DE INSTR WAP WL 2660 TURBO	1	-
*	FW009636	CX WAP WL 2660 TURBO	1	-
*	ECB00233	ETIQ C. BAR WAP WL 2660 TURBO 127V	1	-
*	ECB00234	ETIQ C. BAR WAP WL 2660 TURBO 220V	1	-
*	ECB00235	ETIQ C. BAR WAP WL 2660 TURBO ULTRA 127V	1	-
*	ECB00236	ETIQ C. BAR WAP WL 2660 TURBO ULTRA 220V	1	-

Lista de Revisões

N°	DESCRIÇÃO	DATA
00	Emissão inicial	14/11/2023
01	Atualização na foto ilustrativa do item FW009690	04/09/2024
02	Ajuste na descrição do item FW009648	17/10/2024
03	Adicionado o item FW006893	08/01/2025



Fresnomaq Indústria de Máquinas S/A
Tel.: (41) 3513-9600 - Fax: (41) 3513-9630
Rua Antônio Singer, 200 - São José dos Pinhais, PR, Brasil
www.wap.ind.br - wap@wap.ind.br