

Wap

CATÁLOGO DE PEÇAS PARA REPOSIÇÃO



ASPIRADOR DE PÓ WAP ROBOT W1000

FW010142

REVISÃO : 04 NOVEMBRO/2024
REFERÊNCIA - VEG02.217

O conteúdo deste documento não deve ser reproduzido ou cedido a terceiros sem a autorização prévia da Fresnomaq Indústria de Máquinas S/A



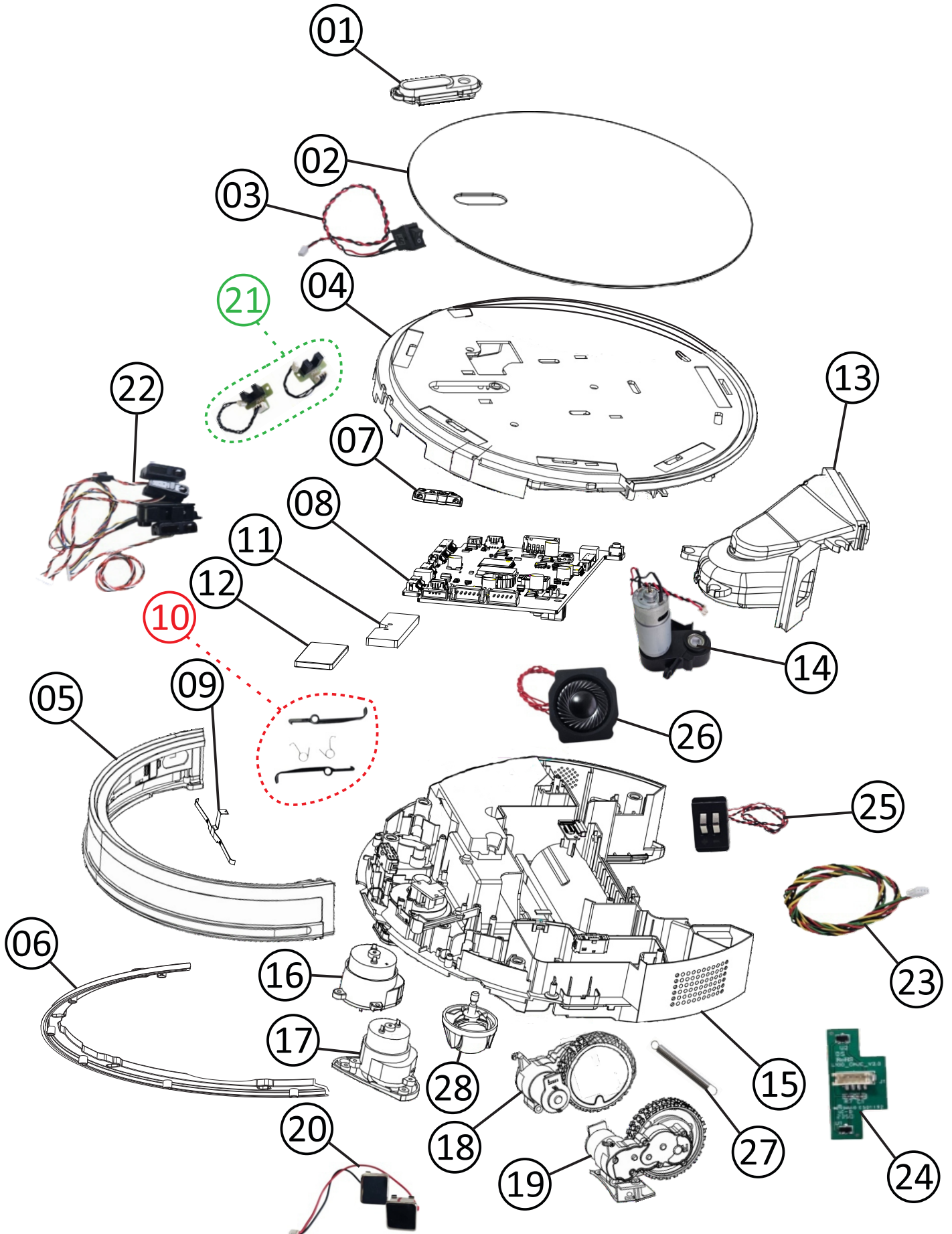

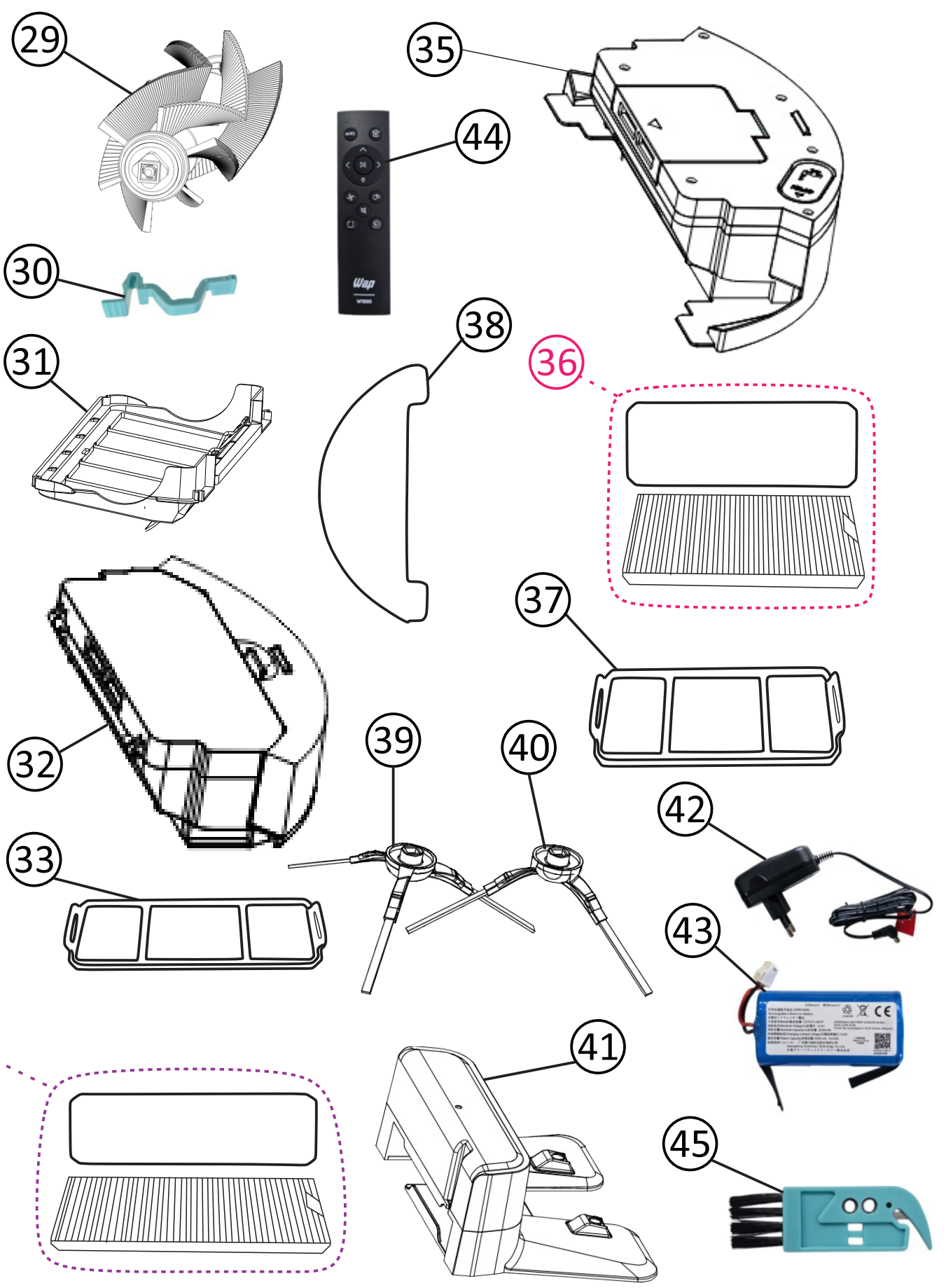

Vista Explodida



Vista Explodida









Lista de Peças

01	FW010285	BOTÃO LIGA / DESLIGA	1	
02	FW010287	TAMPA SUPERIOR DE VIDRO	1	
03	FW010286	INTERRUPTOR	1	
04	FW010288	CARENAGEM SUPERIOR	1	
05	FW010321	BARRA DE IMPACTO SUPERIOR	1	
06	FW010316	KIT BARRA DE IMPACTO INFERIOR	1	
07	FW010289	PCB LIGA / DESLIGA	1	
08	FW010290	PLACA ELETRÔNICA DE COMANDO	1	
09	FW010291	AMORTECEDOR METALICO	1	
10	FW010292	KIT SUPORTE DE COLISÃO	1	











Lista de Peças

11	FW010293	CONTRA PESO (338 g)	1	
12	FW011343	CONTRA PESO (80 g)	1	
13	FW010294	MOTOR DE SUÇÃO	1	
14	FW010295	KIT MOTOR DA ESCOVA ROTATIVA CENTRAL	1	
15	FW010296	CARENAGEM INFERIOR	1	
16	FW010298	CONJ. MOTOR ESCOVA FRONTAL ESQUERDA (L)	1	
17	FW011185	CONJ. MOTOR ESCOVA FRONTAL DIREITA (R)	1	
18	FW010299	KIT MOTOR / RODA ESQUERDA (L)	1	
19	FW010300	KIT MOTOR / RODA DIREITA (R)	1	
20	FW010307	CONTATO DE CARREGAMENTO	1	

Lista de Peças

21	FW010308	KIT SENSORES DE IMPACTO	1	
22	FW010309	KIT PCB + SENSORES INFRAVERMELHO + SENSOR ANTIQUEDA	1	
23	FW011253	CHICOTE ELÉTRICO	1	
24	FW011320	SENSOR DOS RECIPIENTES	1	
25	FW011321	CONECTOR DE ALIMENTAÇÃO PARA BOMBA DE ÁGUA	1	
26	FW011322	ALTO FALANTE 8Ω 1W	1	
27	FW010310	MOLA DA RODA	2	
28	FW010317	RODIZIO FRONTAL	1	
29	FW010301	ESCOVA CENTRAL	1	
30	FW011319	TRAVA DA ESCOVA CENTRAL	1	

Lista de Peças

31	FW010302	TAMPA DA ESCOVA CENTRAL	1	
32	FW010304	RECIPIENTE DE PÓ	1	
33	FW011249	FILTRO TELA RECIPIENTE DE PÓ	1	
34	FW010313	KIT FILTRO HEPA E ESPUMA RECIPIENTE DE PÓ	1	
35	FW010305	RECIPIENTE DE ÁGUA	1	
36	FW010312	KIT FILTRO HEPA E ESPUMA RECIPIENTE DE ÁGUA	1	
37	FW011247	FILTRO TELA RECIPIENTE DE ÁGUA	1	
38	FW010306	REFIL MOP	1	
39	FW010311	ESCOVA FRONTAL ESQUERDA (L)	1	
40	FW011245	ESCOVA FRONTAL DIREITA (R)	1	

Lista de Peças

41	FW010314	BASE CARREGADORA	1	
42	FW010315	CARREGADOR BIVOLT 19V 0.8A	1	
43	FW010303	BATERIA 14.4V 2600mAh	1	
44	FW010318	CONTROLE REMOTO	1	
45	FW011323	ESCOVA PARA LIMPEZA	1	
*	FW010144	CX WAP ROBOT W1000	1	-
*	FW010143	MANUAL DE INSTR WAP ROBOT W1000	1	-
*	ECB00324	ETIQ C. BAR WAP ROBOT W1000	1	-
*	ESL00061	ETIQ SELO RUÍDO WAP ROBOT W1000	1	-

DIAGRAMA ELÉTRICO

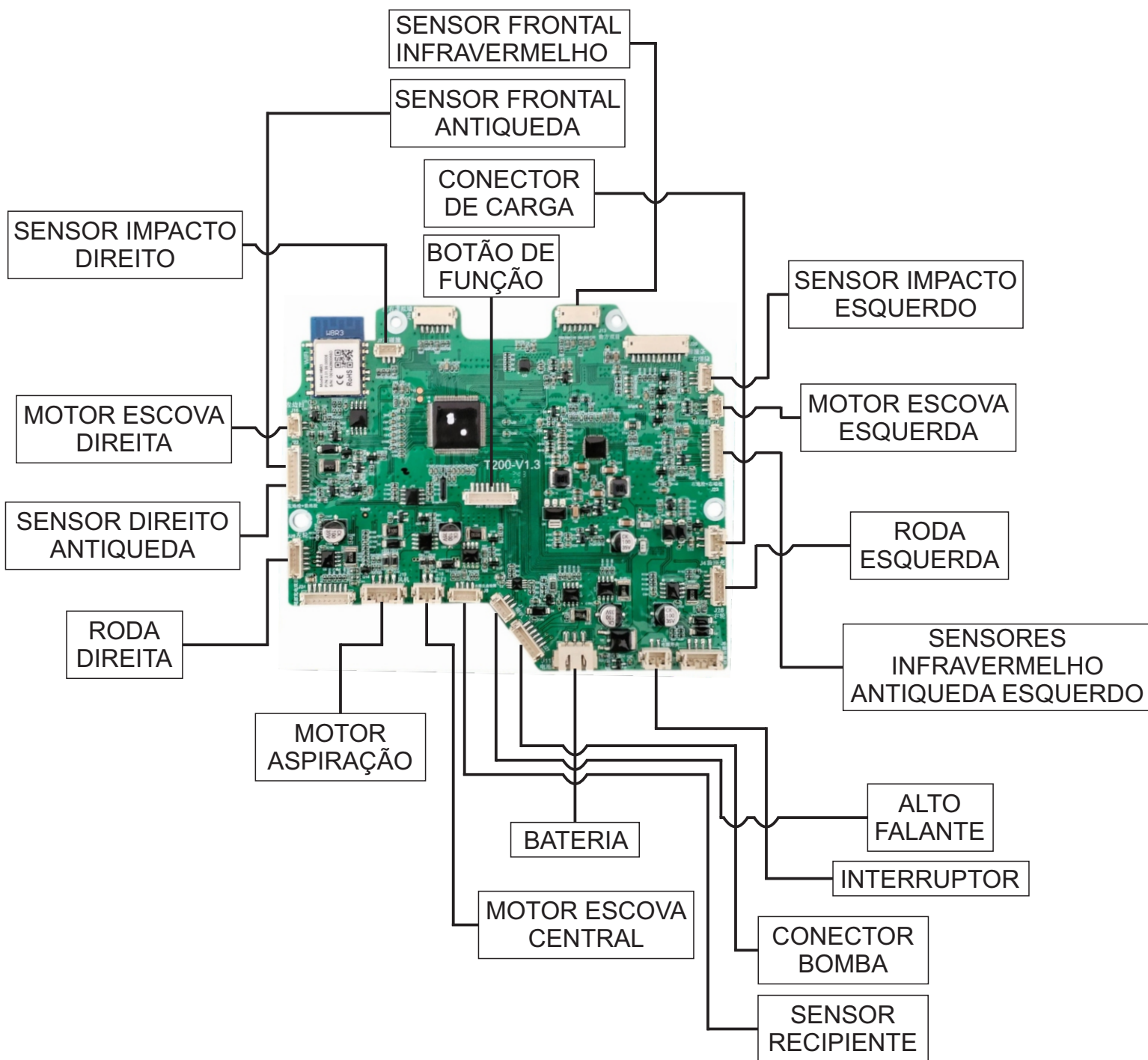

Lista de Revisões

N°	DESCRIÇÃO	DATA
00	Emissão inicial	21/10/2024
01	Adicionados os itens: FW011323, FW010318, FW011245, FW011247, FW011249, FW011319 FW011322, FW011321, FW011320 e ESL00061	23/10/2024
02	Item FW011253 adicionado.	01/11/2024
03	Remoção do item FW010297	04/11/2024
04	Item FW011343 adicionado	13/11/2024



Fresnomaq Indústria de Máquinas S/A
Tel.: (41) 3513-9600 - Fax: (41) 3513-9630
Rua Antônio Singer, 200 - São José dos Pinhais, PR, Brasil
www.wap.ind.br - wap@wap.ind.br