

WAP CAFETEIRA DIGITAL AROMA WCD1500



CÓDIGO 127V: FW010084

CÓDIGO 220V: FW010085

REVISÃO: 00 – OUTUBRO/2024
REFERÊNCIA: VEG02.219

O conteúdo deste documento não deve ser reproduzido ou cedido a terceiros sem autorização prévia da Fresnomaq Indústria de Máquinas S/A

VISTA EXPLODIDA

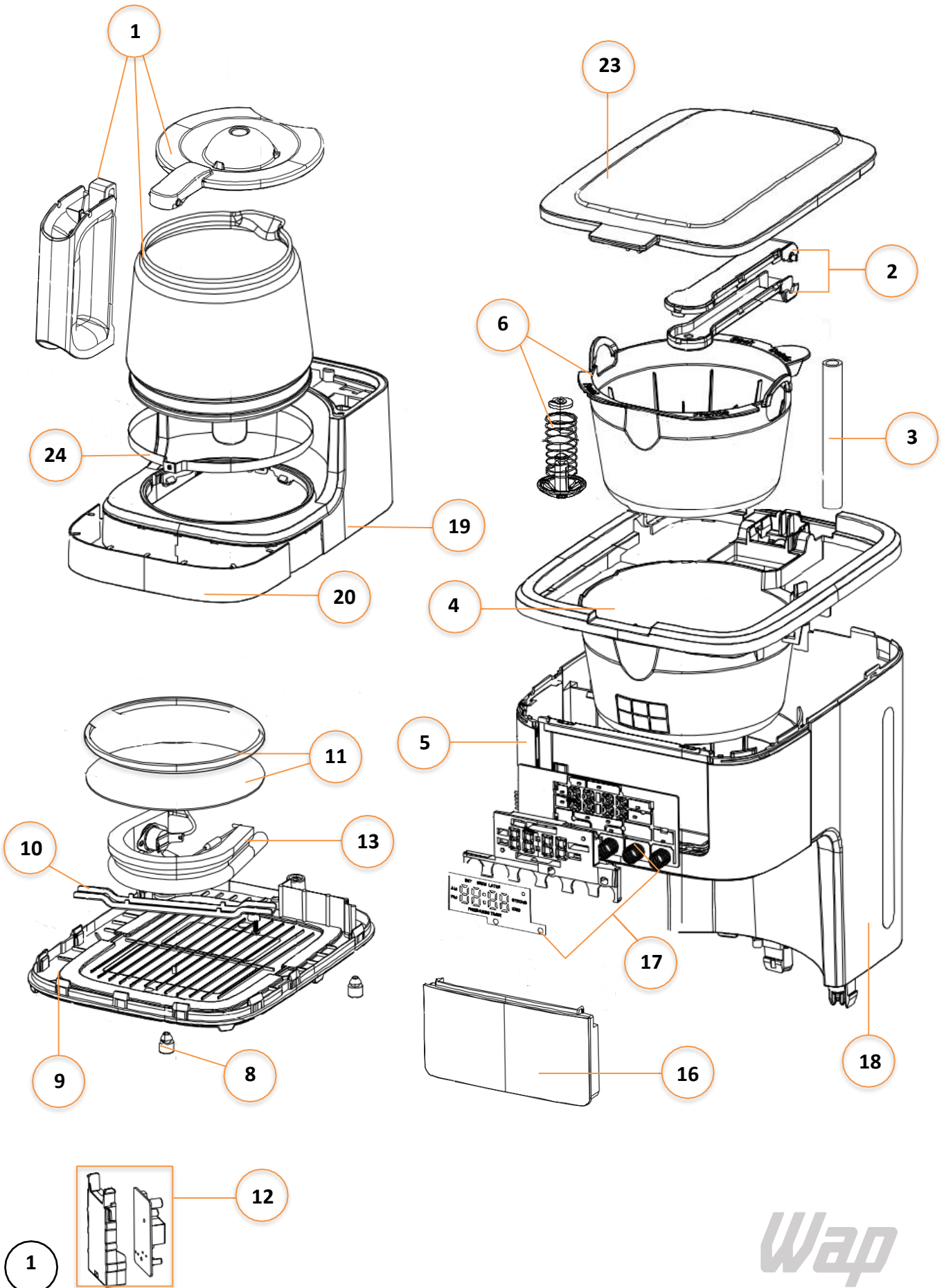

VISTA EXPLODIDA



21

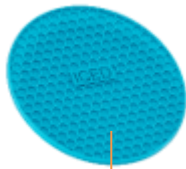

22



7

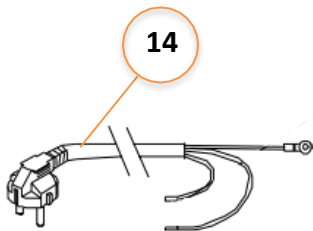

14

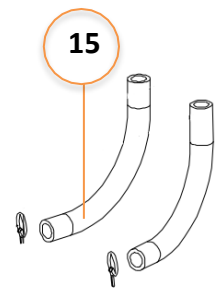





15





LISTA DE PEÇAS

POS	CÓDIGO	DESCRIÇÃO	QUANT.	FOTO ILUSTRATIVA
1	FW010983	JARRA COMPLETA	1	
2	FW010984	ALAVANCA DA TAMPA	1	
3	FW010986	CONDUTOR DE VAPOR	1	
4	FW010987	SUPORTE DO FUNIL	1	
5	FW010985	PLACA DO TANQUE DE ÁGUA	1	

LISTA DE PEÇAS

POS	CÓDIGO	DESCRIÇÃO	QUANT.	FOTO ILUSTRATIVA
6	FW010988	FUNIL	1	
7	FW010989	FILTRO REMOVÍVEL	1	
8	FW010990	PÉS DE BORRACHA	2	
9	FW010991	TAMPA INFERIOR	1	
10	FW010992	BRAÇADEIRA	1	





LISTA DE PEÇAS

POS	CÓDIGO	DESCRIÇÃO	QUANT.	FOTO ILUSTRATIVA
11	FW010993	KIT PLACA DE AQUECIMENTO E ANEL DE VEDAÇÃO	1	
12	FW010994	PCB	1	
13	FW010995	RESISTÊNCIA 127V	1	
	FW010996	RESISTÊNCIA 220V	1	
14	FW010997	CABO ELÉTRICO	1	

LISTA DE PEÇAS

POS	CÓDIGO	DESCRIÇÃO	QUANT.	FOTO ILUSTRATIVA
15	FW010998	TUBOS DE SILICONE	2	
16	FW010999	PAINEL DE CONTROLE	1	
17	FW011000	CONJUNTO LED PCB	1	
18	FW011001	TANQUE DE ÁGUA	1	
19	FW011002	BASE DO TANQUE DE ÁGUA	1	

LISTA DE PEÇAS

POS	CÓDIGO	DESCRIÇÃO	QUANT.	FOTO ILUSTRATIVA
20	FW011003	PLACA DA BASE	1	
21	FW011004	COLHER DOSADORA	1	
22	FW011005	SUPORTE DE CAFÉ GELADO	1	
23	FW011006	TAMPA	1	
24	FW011007	ANEL PARA JARRA	1	

LISTA DE PEÇAS

POS	CÓDIGO	DESCRIÇÃO	QUANT.	FOTO ILUSTRATIVA
*	FW010086	CX WAP CAFETEIRA DIGITAL AROMA WCD1500	1	
*	FW010087	MANUAL DE INSTR WAP CAFETEIRA DIGITAL AROMA WCD1500	1	
*	ECB00326	ETIQ.C. WAP CAFETEIRA DIGITAL AROMA WCD1500 127V		
*	ECB00327	ETIQ.C. WAP CAFETEIRA DIGITAL AROMA WCD1500 220V		

LISTA DE REVISÕES

Nº	DESCRIÇÃO	DATA
00	Emissão Inicial	21/10/2024