

WAP ROBOT W90 PÉROLA



CÓDIGO: FW010260







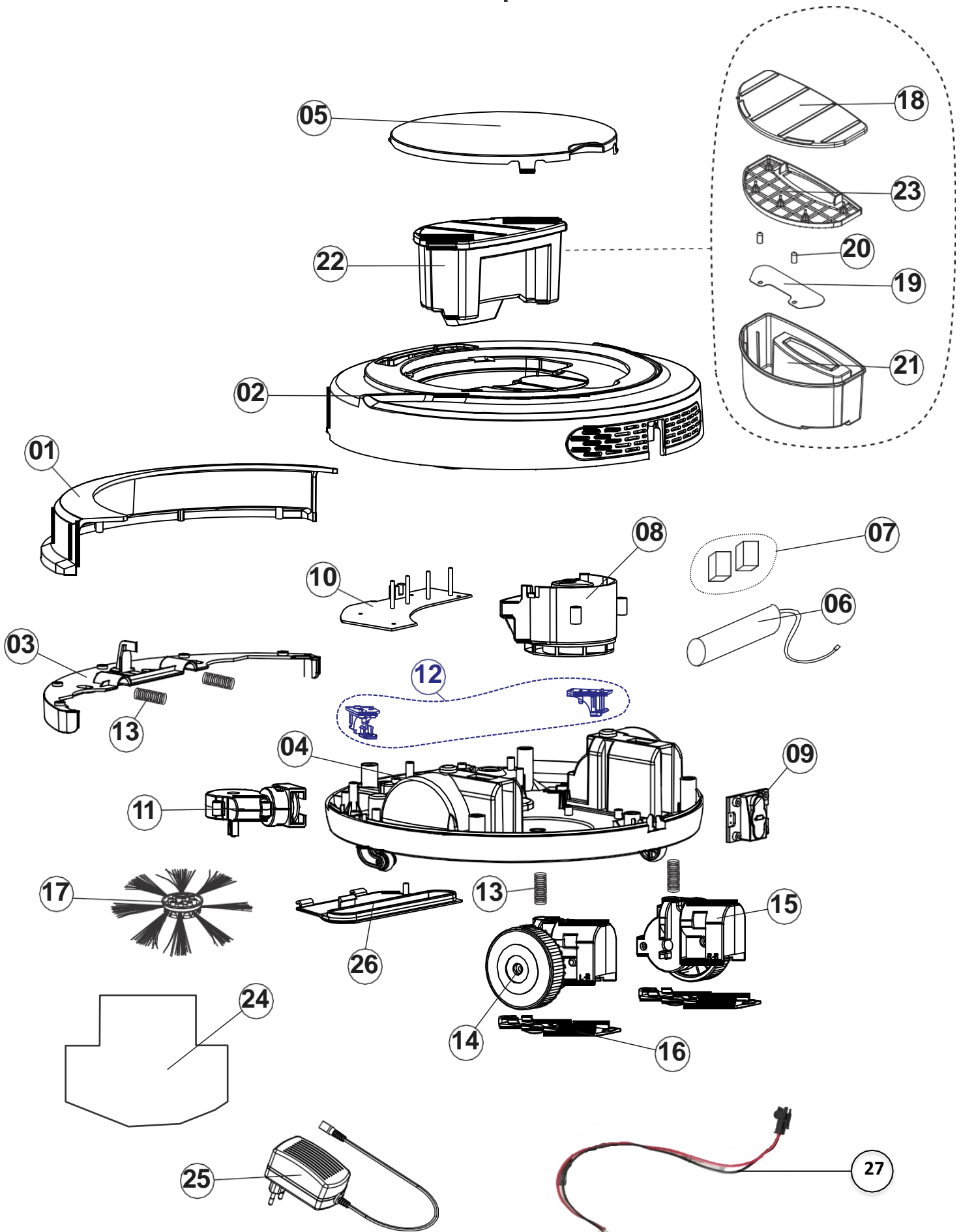



REVISÃO: 00 – NOVEMBRO/2024
REFERÊNCIA: VEG02.220

O conteúdo deste documento não deve ser reproduzido ou cedido a terceiros sem autorização prévia da Fresnomaq Indústria de Máquinas S/A











Vista Explodida



Lista de Peças

01	FW011256	PARACHOQUE FRONTAL	1	
02	FW011257	CARENAGEM SUPERIOR	1	
03	FW011258	TAMPA INFERIOR DO PARACHOQUE	1	
04	FW011259	CARENAGEM INFERIOR	1	
05	FW011260	TAMPA SUPERIOR	1	
06	FW009121	BATERIA 3.6V 2600mAh	1	
07	FW009122	KIT EVA DE SUPORTE DA BATERIA	1	
08	FW009123	KIT MOTOR SUÇÃO	1	
09	FW009124	CONECTOR DE CARGA	1	
10	FW009125	PLACA ELETRÔNICA (PCB)	1	

Lista de Peças

11	FW009126	KIT MOTOR ESCOVA FRONTAL	1	
12	FW009127	KIT SENSOR PEQUENO	1	
13	FW009128	MOLA	4	
14	FW009129	KIT MOTOR RODA ESQUERDA	1	
15	FW009130	KIT MOTOR RODA DIREITA	1	
16	FW011261	TAMPADA RODA	2	
17	FW009132	ESCOVA FRONTAL	1	
18	FW007699	TAMPADO FILTRO	1	
19	FW007702	TAMPA DA ENTRADA DE SUCCÃO	1	
20	FW007701	PINO DE FIXAÇÃO	2	

Lista de Peças





21	FW007703	RECIPIENTE DE PÓ	1	
22	FW008543	RECIPIENTE DE PÓ COMPLETO	1	
23	FW007700	FILTRO DE ENTRADA	1	
24	FW007845	REFIL MOP	1	
25	FW009133	CARREGADOR 5V 0.2A	1	
26	FW011262	RODO DE SUCCÃO	1	
27	FW011400	CHICOTE ELÉTRICO PARA CONEXÃO DA BATERIA	1	
*	FW010263	CX WAP ROBOT W90 PÉROLA	1	-
*	FW010264	MANUAL DE INSTR WAP ROBOT W90 PÉROLA	1	-
*	ECB00333	ETIQ C. BAR WAP ROBOT W90 PÉROLA	1	-
*	ESL00062	ETIQ SELO RUÍDO WAP ROBOT W90 PÉROLA	1	-

Diagrama Elétrico



Lista de Revisões

N°	DESCRIÇÃO	DATA
00	Emissão inicial	12/11/2024

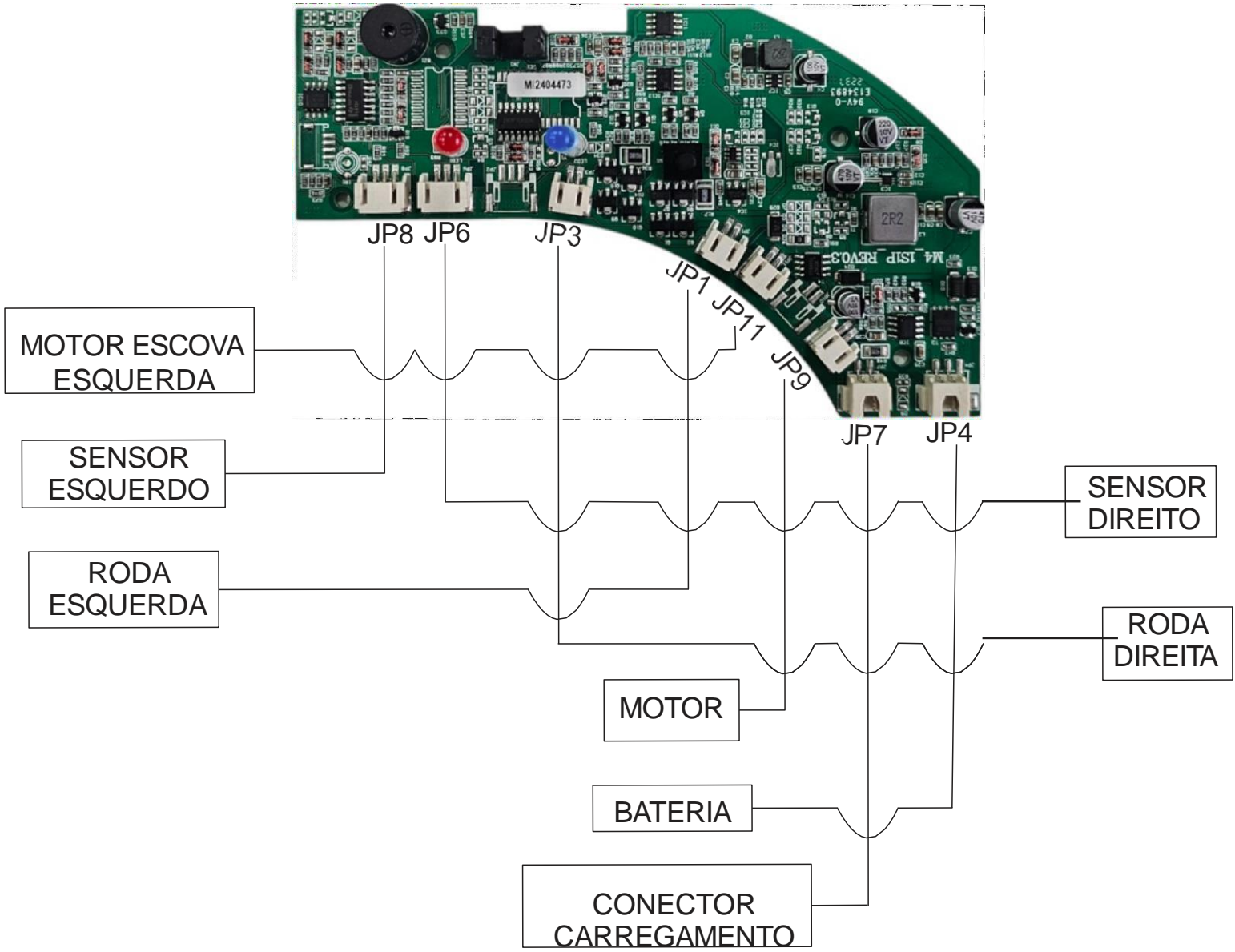

Fresnomaq Indústria de Máquinas S/A
Tel.: (41) 3513-9600 - Fax: (41) 3513-9630
Rua Antônio Singer, 200 - São José dos Pinhais, PR, Brasil
www.wap.ind.br - wap@wap.ind.br