

# Wap<sup>®</sup>









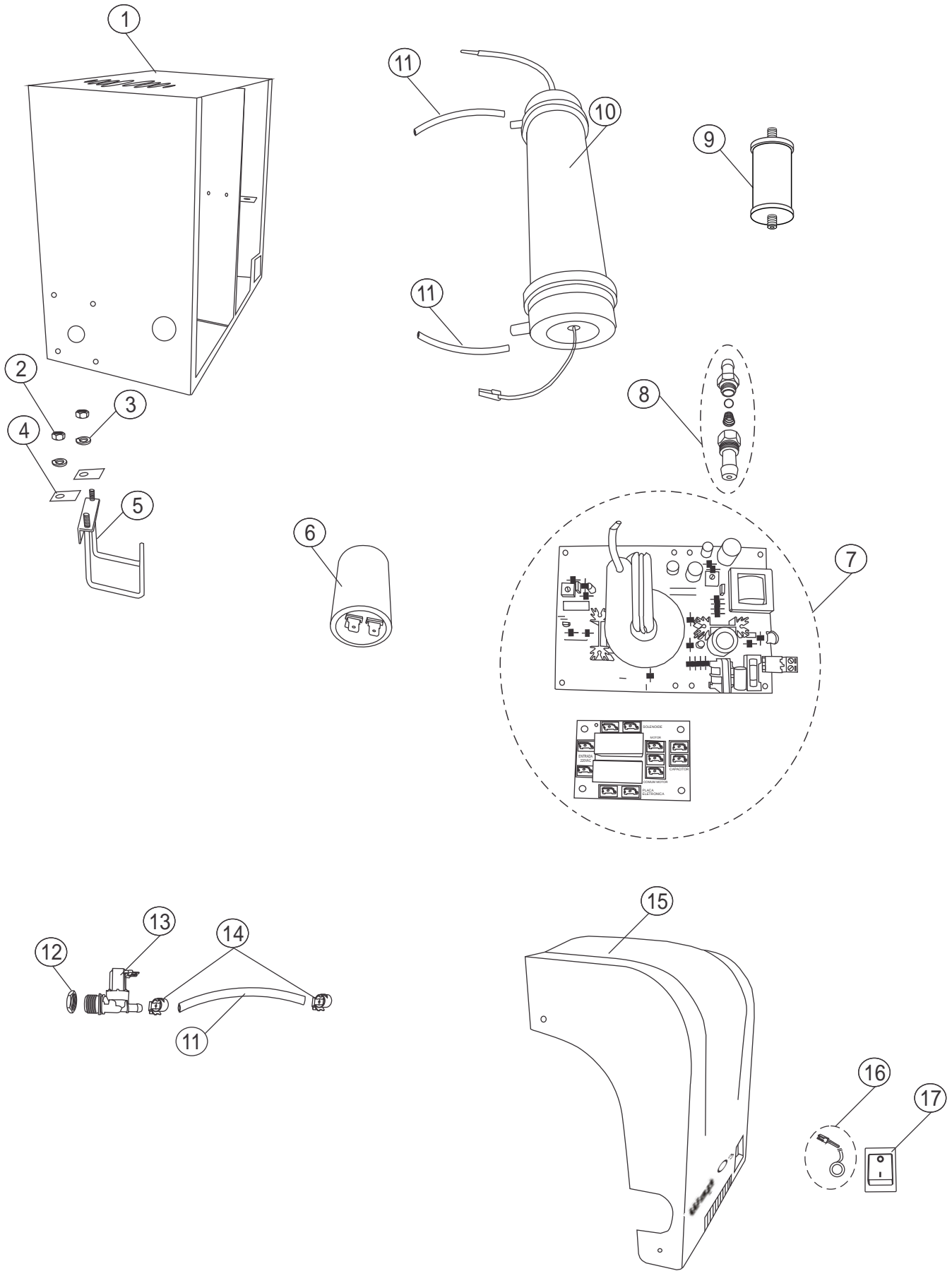







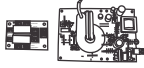

## Wap<sup>®</sup> O<sub>3</sub>

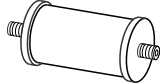
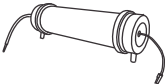
catálogo para reposição de peças

# Vista Explodida







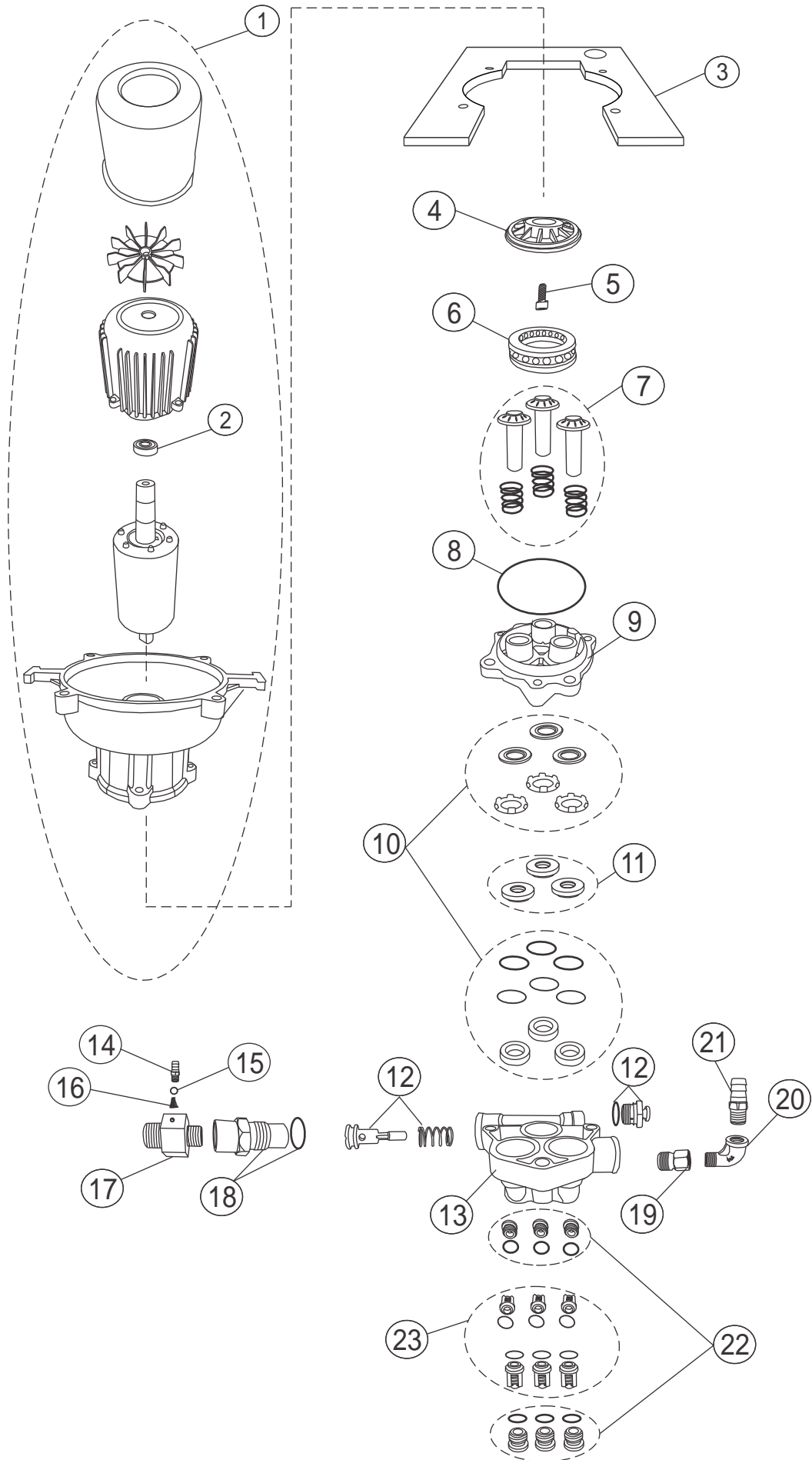

# Lista De Peças 1

Item	Código	Descrição	Qtde.	Desenho
1	20011103	COFRE 03 CPL	1	
2	14144000	PORC SEXT M8 ZN	2	
3	70001008	ARR PRESS 8mm ZN	2	
4	20011111	ARRUELA REFORÇO QUADRADA COFRE 03	2	
5	20011109	SUORTE P/ MANGUEIRA COFRE 03	1	
6	APW90-47	CAPAC 80µF 250vca BRAVO 127V	1	
6	APW90-47A	CAPAC 82µF 450vca BRAVO 220V	1	
7	20011162	PLACA BORNEIRA PCI O3 CPL	1	
8	20011199	VALV RETENÇÃO 1/8 PVC WAP O3	1	
9	20011124	FILTRO SECADOR 3/8 UNF LAVAD O3	1	
10	20011134	CAPSULA GERADORA O3 LAVAD O3	1	
11	20011123	MANG SILICONE 8x3,5mm (KIT COM 03 MANGUEIRAS)	1	
12	70020165	PORC SEXT 3/4"	1	
13	20011153	SOLENOIDE 127V 3/4 BSP RETA EMICOL LAVAD O3	1	
13	20011154	SOLENOIDE 220V 3/4 BSP RETA EMICOL LAVAD O3	1	
14	70000106	ABRAÇ AÇO 12-16	2	
15	20011113	CARENAGEM FRONTAL LAVAD O3	1	
16	20011168	LED INDICADOR DE O3	1	
17	60867000	INTERR ASPO AERO	1	

# Vista Explodida

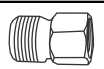

# Lista De Peças 1

Item	Código	Descrição	Otde.	Desenho
1	APW90-73	MT 127V/60Hz BRAVO VERSÃO II	1	
1	APW90-73A	MT 220V/60Hz BRAVO VERSÃO II	1	
2	19524000	ROLAM 6302 2RS	1	
3	20011110	BASE FIXAÇÃO CONJ MOTO-BOMBA WAP O3	1	
4	APW90-74	CAME (BRAVO) VERSÃO II	1	
5	VB70-0029	PARF CAME M8x20 (PLUS/SUPER/PREM/TOP/EXCEL/VALEN/BRAV)	1	
6	VG70-0054	ROLAM AXIAL (EXCEL/PLUS/SUPER/VALEN/BRAV)	1	
7	VB70-49-51	KIT N° 7 PISTÕES (PLUS/SUPER/PREM/COMPACT/EXCEL/BRAV/VALEN)	1	
8	50043202	O-RING 58,42x2,62 (2-141)	1	
9	VG70-0034	GUIA PISTÕES (EXCEL/PLUS/SUPER/VALEN) VERSÃO II/III	1	
10	VB70-44-48	KIT N° 6 VEDAÇÃO (PLUS/SUP/VALEN/EXCEL/PREM/BRAV)	1	
11	VB70-0040	KIT ANEL CENTR CPL (PLUS/SUPER/PREM/COMPACT/EXCELL/BRAV/VAL)	1	
12	20011197	KIT BPS WAP O3	1	
13	VG70-0017	CABEÇOTE (EXCEL/VALEN/PLUS/SUPER/BRAVO) VERSÃO II/III	1	
14	20011122	ESPIGÃO ADITIVO INOX LAVAD O3	1	
15	13238000	ESFERA AÇO INOX 440 (5,556mm)	1	
16	13239000	MOLA CONIC CONEX SUCC INOX	1	
17	20011169	CONEXÃO ADITIVO INOX LAVAD O3 CPL	1	
18	20011198	CONEXÃO SAÍDA WAP O3	1	
19	20011114	UNIÃO ENTR (M) M16x1/4 BSP (F) LAV O3	1	
20	20011115	JOELHO 1/4 FG	1	
21	20011116	ESPIGÃO ENTR 1/4	1	
22	VG70-41-42	KIT N° 5 TAMP VALV (EXCEL/VALEN/PLUS/SUP/BRAV) VERSÃO II/III	1	
23	VG70-36-40	KIT N° 4 VALV S/P (EXCEL/VALEN/PLUS/SUP/BRAV) VERSÃO II/III	1	

# Vista Explodida

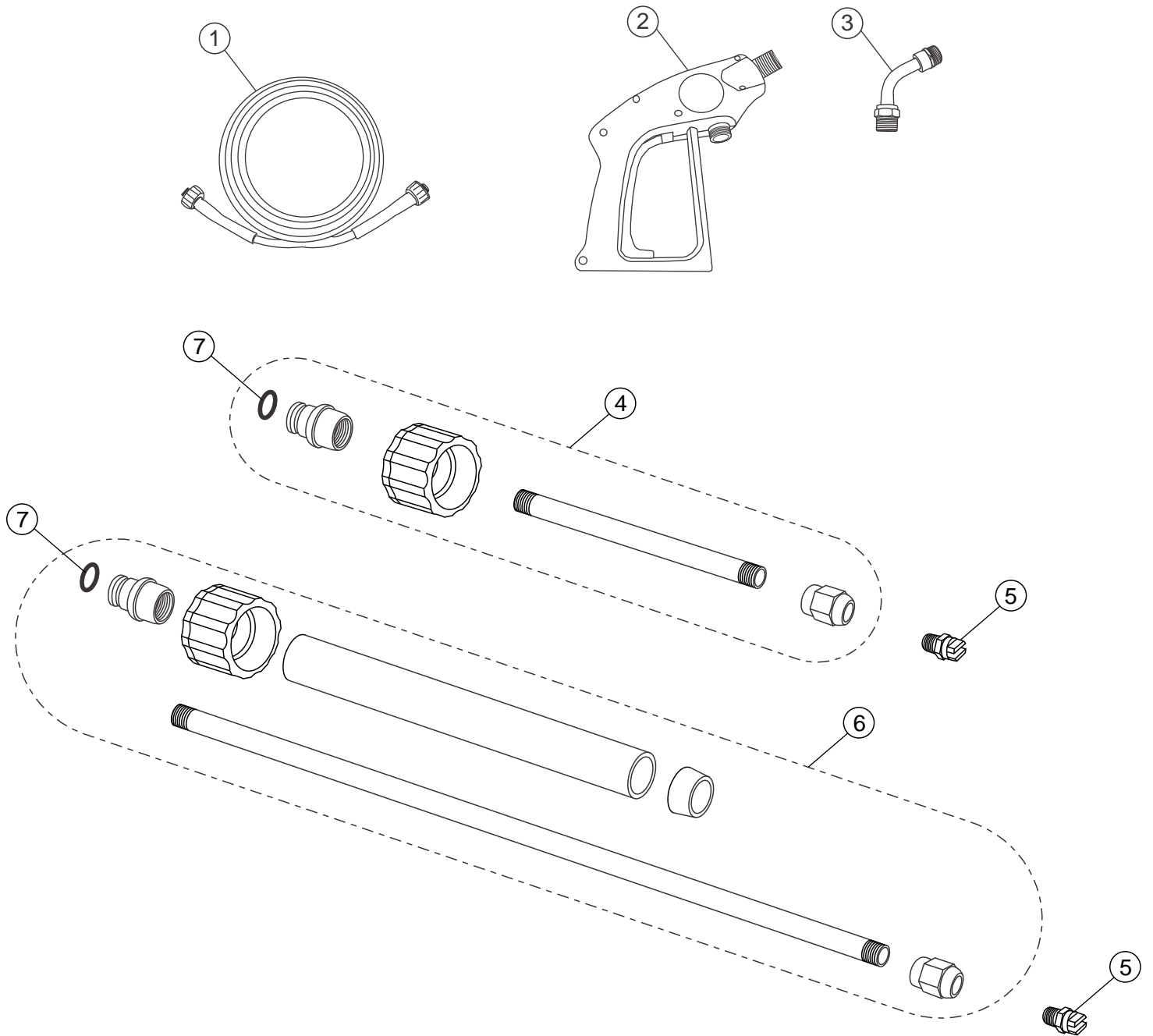

# Lista De Peças 2

Item	Código	Descrição	Qtde.	Desenho
1	20011170	MANGUEIRA AP 1/4" PVC 10M LAVAD O3	1	
2	20011150	PISTOLA EKO INOX CPL LAVAD O3	1	
3	20011149	TUBO PISTOLA EKO INOX CPL	1	
4	20011151	INOX 120mm CPL LAVAD O3	1	
5	78130003	BICO AP W-2510 1/8 MEG	1	
6	20011152	LANÇA INOX 670mm CPL LAVAD O3	1	
7	20011146	O'RING 9,19 x 2,62 (2110) SILICONE	1	



**Marca de Profissional**

Fresnomaq Indústria de Máquinas S/A  
Tel.: (41) 2102 0300 - Fax: 2102 0334  
Rua Francisco Dal Negro, 3400, São José dos Pinhais, Pr, Brasil  
[www.wap.ind.br](http://www.wap.ind.br) - [wap@wap.ind.br](mailto:wap@wap.ind.br)