

Wap[®]





wapore
Fast

catálogo para reposição de peças

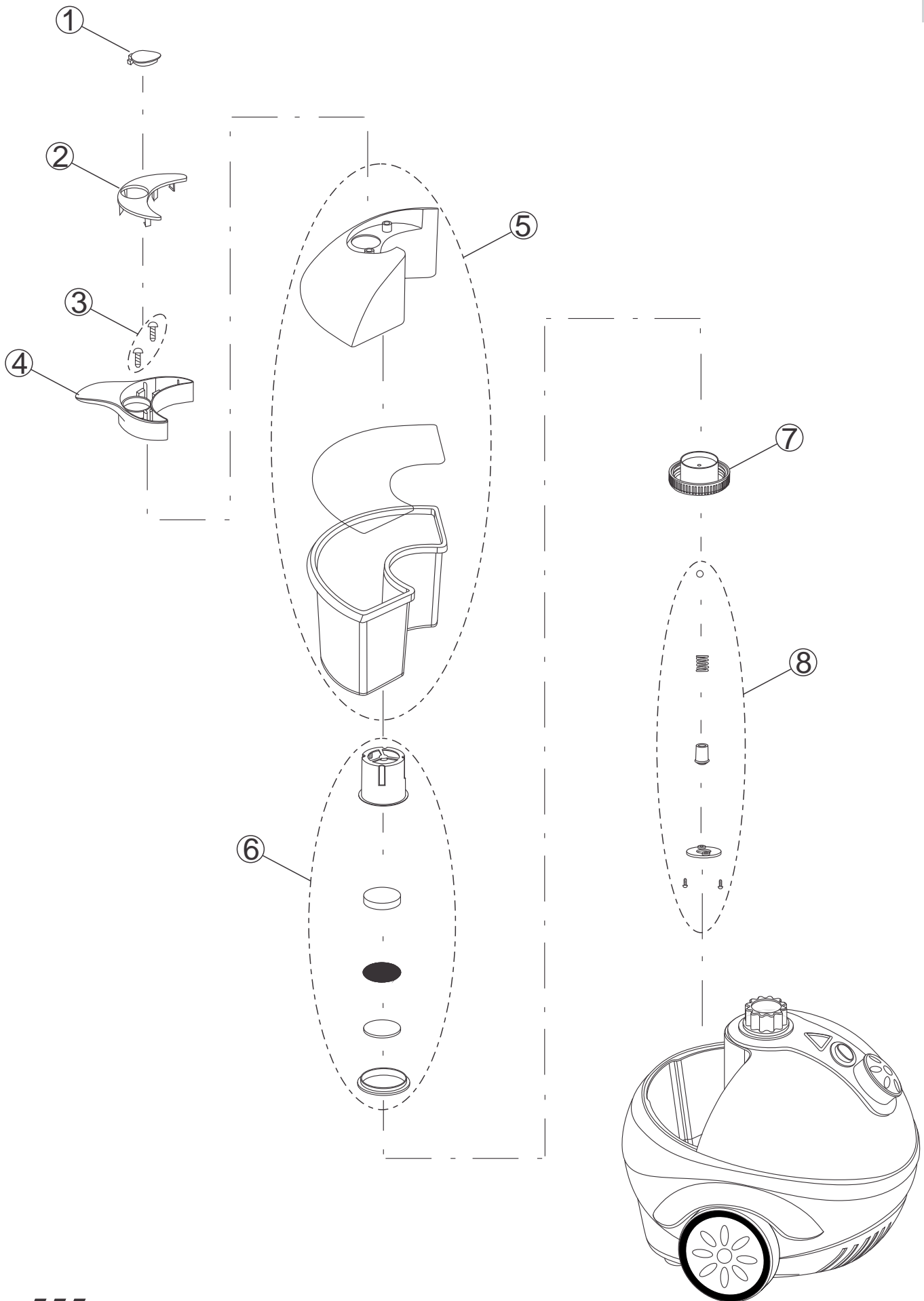
Vista Explodida

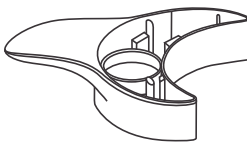
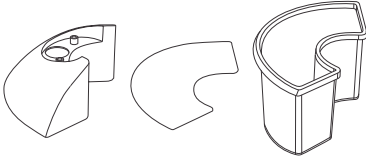
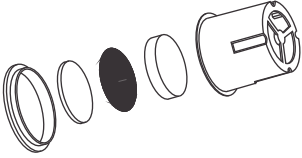
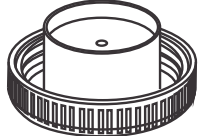
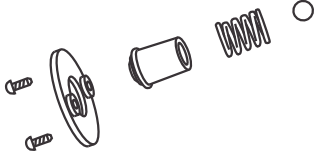

Lista De Peças 1

Item	Código	Descrição	Qtde.	Desenho
1	20011721	TAMPA RECIPIENTE W-FAST	1	
2	20011722	PARF AP-CP-FC 3,9 x 11,3	2	
3	20011723	TAMPA DA ALÇA DO RECIPIENTE W-FAST	1	
4	20011724	ALÇA RECIPIENTE W-FAST	1	
5	20011725	CJ RECIPIENTE W-FAST	1	
6	20011726	KIT FILTRO W-FAST	1	
7	20011727	TAMPA INFERIOR RECIPIENTE W-FAST	1	
8	20011728	VALV. RETENÇÃO	1	



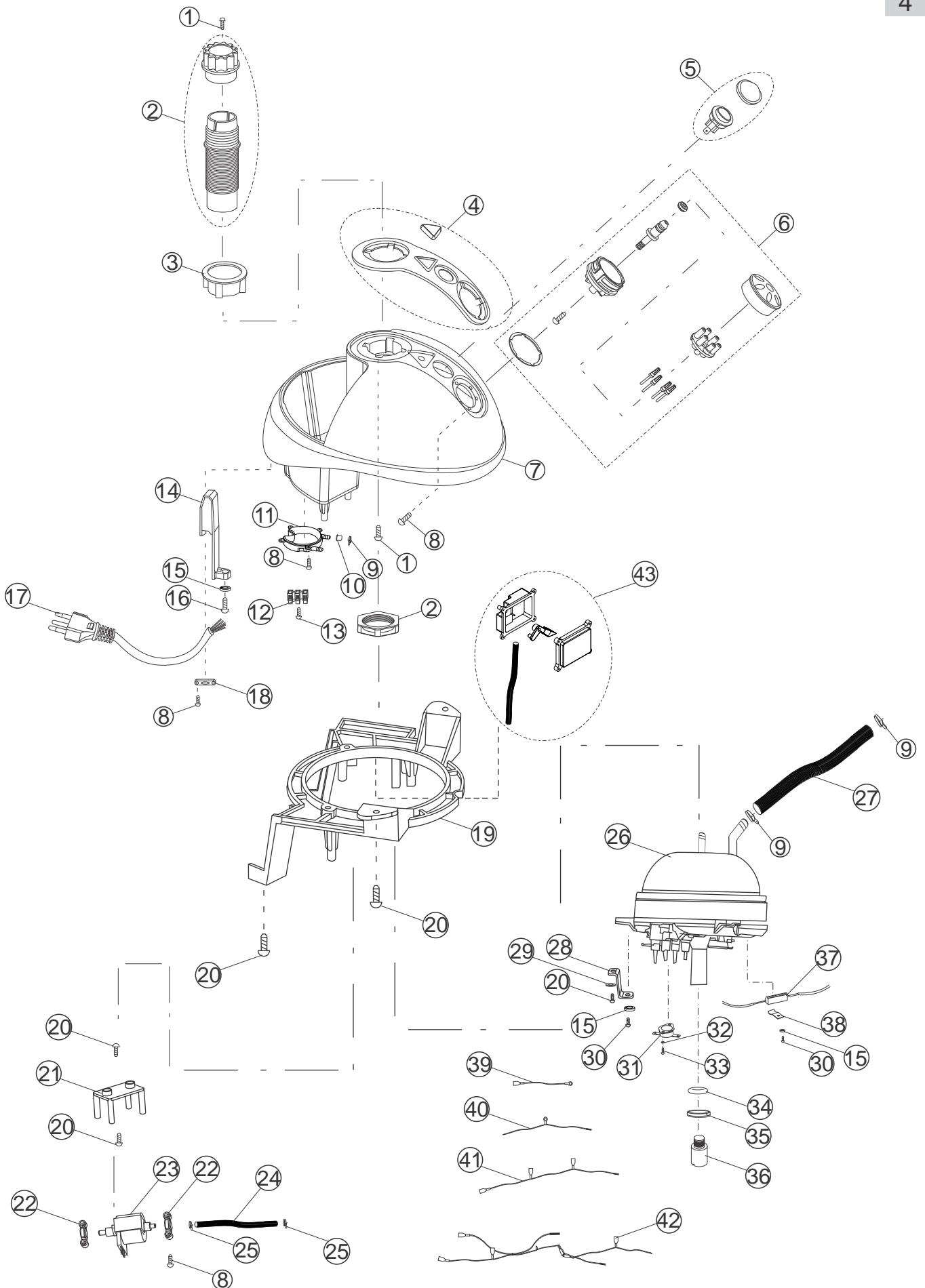

















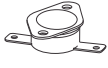

Vista Explodida

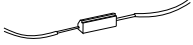

Lista De Peças 1

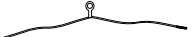
Pos: Do Item	Código	Descrição	Qtde.	Desenho
1	50170000	PARF PP 3,5x14 CP-FC ZN	5	
2	20011729	CJ SUPTE HASTE	1	
3	20011730	GUIA SUPTE HASTE	1	
4	20011731	PAINEL (ACRÍLICO)	1	
5	20011732	INTERRUPTOR	1	
6	20011733	CONECTOR DUTO DE VAPOR	1	
7	20011734	CARENAGEM SUPERIOR	1	
8	20010807	PARF AA 3x10mm	12	
9	20011735	ABRAÇADEIRA MOLA 7,5mm	3	
10	20011736	TAMPA CONEX. ENTRADA CALDEIRA	1	
11	20011737	CONEXÃO ENTRADA CALDEIRA	1	
12	20011738	TERMINAL BORNE C/ 03	1	
13	31040015	PARF AA 14x3 CP-FC ZN	1	
14	20011739	SUPTE DO CABO	1	
15	FW000340	ARR. PRESS. 4mm	5	
16	20011740	PARF PP 4x10mm CP-FC ZN	1	
17	20011741	CABO 3x1,5 2m	1	
18	20011742	PRENSA CABO	1	
19	20011743	SUPTE DA CALDEIRA	3	
20	20010814	PARF AA 4x12mm	9	
21	20011744	BASE DA BOMBA W.FAST	1	
22	20011745	SUPTE BOMBA W.FAST	2	

Lista De Peças 2

Pos: Do Item	Código	Descrição	Qtde.	Desenho
23	20011746	BOMBA 127V W.FAST	1	
23	20011747	BOMBA 220V W.FAST	1	
24	20011748	MANG. SILICONE 4x2x170mm (TRAMA FIBRA)	1	
25	20011749	ABRAÇADEIRA MOLA 6mm	2	
26	20011750	CALDEIRA W.FAST 127V	1	
26	FW001161	CALDEIRA W.FAST 220V	1	
27	20011751	MANG. SILICONE 5x2x250mm (TRAMA FIBRA)	1	
28	20011752	TRAVA CALDEIRA	3	
29	20011753	ARR. NYLON 1x4x8mm	3	
30	20011754	PARF M4X6MM CP-FC	4	
31	20011755	TERMOSTATO W.FAST	2	
32	20011756	ARR. PRESS. 3mm	3	
33	20011757	PARF M3x5 CP-FC	3	
34	20011758	ORING 2,4x7,3 (6801) SILICONE	1	
35	20011759	PORTA ORING	1	
36	20011760	BUJÃO DA CALDEIRA	1	
37	20011761	CHICOTE INTER./BORNE	1	
38	20011762	FIXADOR CHICOTE	1	
39	20011763	CHICOTE CALDEIRA	1	
40	20011764	CHICOTE ATERRAMENTO	1	
41	20011765	CHICOTE INTER./CONNECT./CALDEIRA	1	
42	20011766	CHICOTE INTER./LED/CALDEIRA/ BOMBA/CONECTOR/SENSOR RED	1	
43	FW001222	CONJ. VALVULA DE SEGURANÇA	1	

Vista Explodida

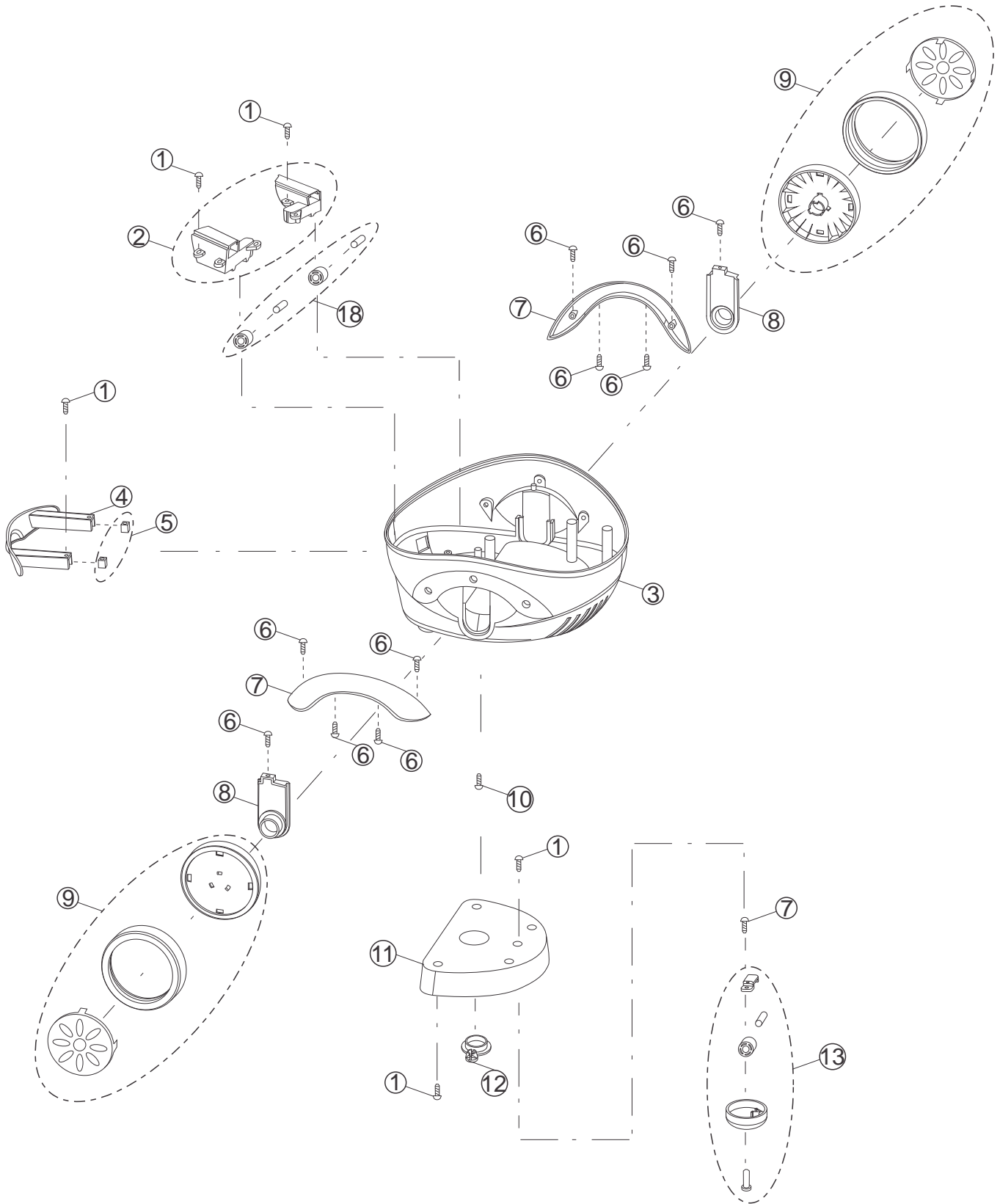

Lista De Peças 2

Pos: Do Item	Código	Descrição	Qtde.	Desenho
1	20010814	PARF AA 4x12mm	15	
2	20011767	CJ SUPTE ALÇA	1	
3	20011768	CARENAGEM INFERIOR	1	
4	20011769	ALÇA W.FAST	1	
5	20011770	TRAVA ALÇA	2	
6	20010807	PARF AA 3x10mm	12	
7	20011771	PARA-LAMA	2	
8	20011772	CJ SUPTE RODA	1	
9	20011773	CJ RODA W.FAST	1	
10	50170000	PARF PP 3,5x14 CP-FC ZN	5	
11	20011774	BASE CARENAGEM INFERIOR	1	
12	20011775	TAMPÃO CALDEIRA	1	
13	20011776	CJ RODÍZO	1	

Lista De Peças 2

Pos: Do Item	Código	Descrição	Qtde.	Desenho
1	20011713	CJ ESCOVA DE PASSAR CPL WAPORE FAST		
2	20011715	CARENAGEM ESCOVA DE PASSAR	1	
3	20011714	INT. ACIONADOR DE VAPOR	1	
4	20011716	VISOR LED DE VAPOR	1	
5	20011717	REGULADOR DE VAPOR	1	
6	20011711	CJ RESISTÊNCIA	1	
7	20011712	CJ DUTO DE VAPOR	1	
8	20011720	FILTRO DUTO DE VAPOR	1	
9	20011777	CHICOTE LED	1	
10	20011738	TERMINAL BORNE C/ 03	1	
11	20011778	MANG SILICONE 4x2x260mm	1	
12	20011749	ABRAÇADEIRA MOLA 6mm	2	
13	20011779	ESPIGÃO W. FAST	1	

Vista Explodida

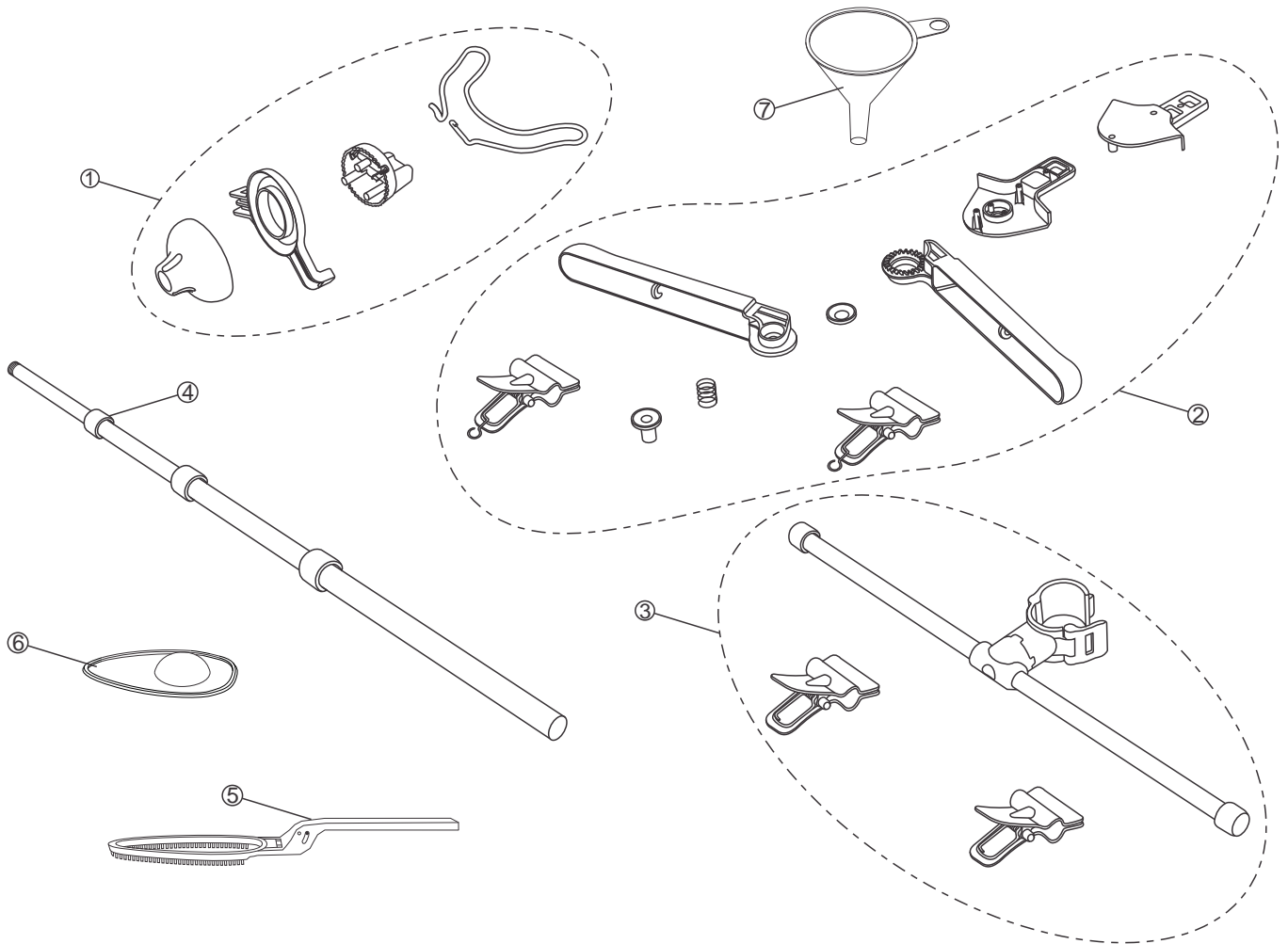

Pos: Do Item	Código	Descrição	Qtde.	Desenho
1	20011708	SUPORE DO PASSADOR WAPORE FAST	1	
2	20011706	CABIDE SUP GIRATÓRIO WAPORE FAST	1	
3	20011707	CABIDE INF GIRATÓRIO WAPORE FAST	1	
4	20011709	HASTE TELESCÓPICA WAPORE FAST	1	
5	20011710	PASSA CALÇAS WAPORE FAST	1	
6	20011780	ESCOVA REMOVEDORA DE PENUGENS WAPORE FAST	1	
7	20011719	FUNIL W.FAST	1	



Marca de Profissional

Fresnomaq Indústria de Máquinas S/A
Tel.: (41) 2102 0300 - Fax: 2102 0334
Rua Francisco Dal Negro, 3400, São José dos Pinhais, Pr, Brasil
www.wap.ind.br - wap@wap.ind.br