

Wap

CATÁLOGO DE PEÇAS PARA REPOSIÇÃO



AIRFRY WAP OVEN BLACK PROSDÓCIMO 12L

FW010508 (127V)
FW010509 (220V)

REVISÃO: 04 - NOVEMBRO/2024
REFERÊNCIA - VEG02.192

O conteúdo deste documento não deve ser reproduzido ou cedido a terceiros sem a autorização prévia da Fresnomaq Indústria de Máquinas S/A

Vista Explodida

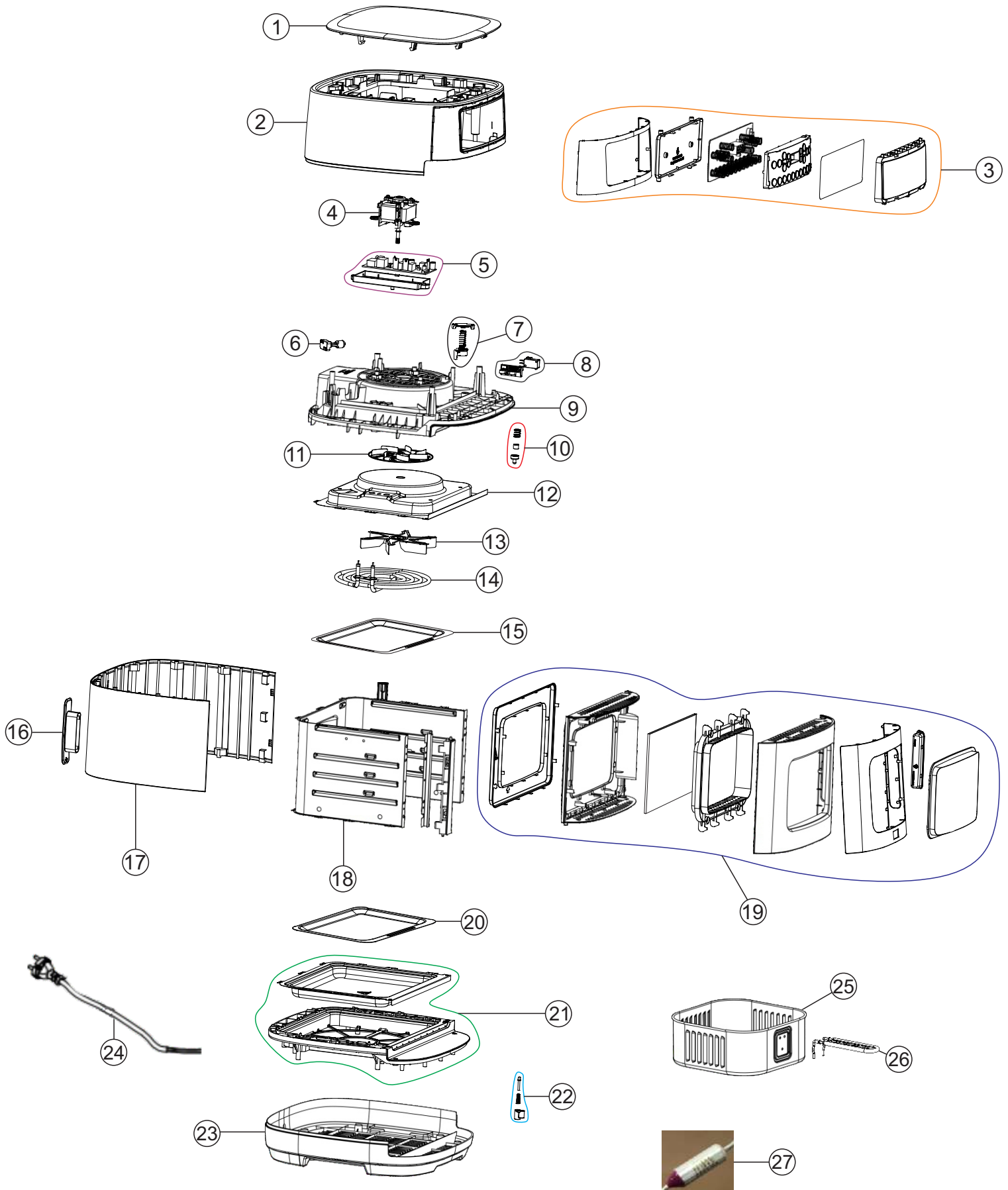







Lista de Peças

01	FW009857	TAMPA SUPERIOR	1	
02	FW010579	SUPORE DO PAINEL	1	
03	FW011263	PAINEL DE FUNÇÕES	1	
04	FW009870	MOTOR 127V	1	
	FW009871	MOTOR 220V		
05	FW011255	PLACA ELETRÔNICA	1	
06	FW009872	LED INDICADOR	1	
07	FW010581	KIT PINO TRAVA DA PORTA	1	
08	FW009873	MICRO INTERRUPTOR	1	
09	FW009868	SUPORE DO MOTOR	1	
10	FW009881	KIT PINO TRAVA SUPERIOR	1	

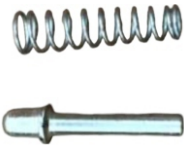
Lista de Peças

11	FW009865	HÉLICE SUPERIOR	1	
12	FW009869	SUPORE DA RESISTÊNCIA	1	
13	FW009864	HÉLICE INFERIOR	1	
14	FW009875	RESISTÊNCIA 127V	1	
	FW009876	RESISTÊNCIA 220V		
15	FW009880	GRELHA	1	
16	FW009862	SUPORE DO CABO ELÉTRICO	1	
17	FW009861	CARENAGEM PLÁSTICA	1	
18	FW009866	CARENAGEM METÁLICA	1	
19	FW010580	PORTA	1	
20	FW009879	CHAPA	1	

Lista de Peças

21	FW009859	SUORTE DA CHAPA	1	
22	FW009877	KIT PINO TRAVA DA PORTA	1	
23	FW009860	BASE	1	
24	FW009884	CABO ELÉTRICO	1	
25	FW009874	CESTO	1	
26	FW009878	ALÇA DO CESTO	1	
27	FW010920	FUSÍVEL TÉRMICO (216°C)	1	
28	FW010511	SENSOR DE TEMPERATURA	1	
*	FW009549	MANUAL DE INSTR WAP AIRFRY OVEN BLACK	1	-
*	FW010510	CX WAP AIRFRY OVEN BLACK	1	-
*	ECB00274	ETIQ. C. BAR WAP AIRFRY OVEN BLACK 127V	1	-
*	ECB00275	ETIQ. C. BAR WAP AIRFRY OVEN BLACK 220V	1	-

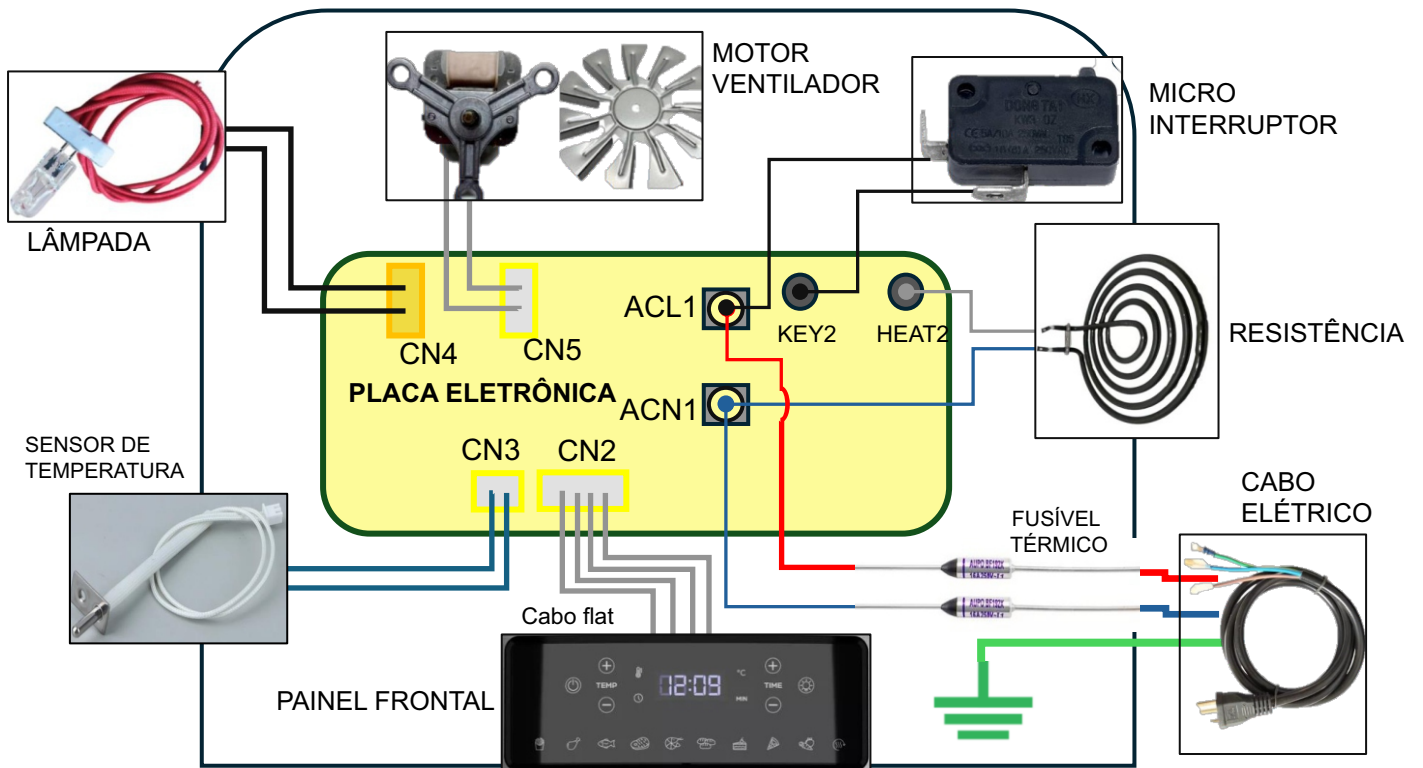

OBSERVAÇÃO

Para produtos fabricados até a semana 22/2024, utilizar os códigos FW009883 (Painel de funções) e FW009882 (Placa eletrônica).

Para produtos fabricados após a semana 22/2024, utilizar os códigos FW011263 (Painel de funções) e FW011255 (Placa eletrônica).

Lista de Revisões

N°	DESCRIÇÃO	DATA
00	Emissão inicial	17/06/2024
01	Alteração do item FW009819 para o FW010920	10/09/2024
02	Remoção do item FW009867 / Acionado o item FW010581	10/10/2024
03	Adicionado esquema elétrico	30/10/2024
04	Os itens FW009883 e FW009882 foram alterados para FW011263 e FW011255	13/11/2024



Fresnomaq Indústria de Máquinas S/A
Tel.: (41) 3513-9600 - Fax: (41) 3513-9630
Rua Antônio Singer, 200 - São José dos Pinhais, PR, Brasil
www.wap.ind.br - wap@wap.ind.br